

Bulletin 932
June 1985

SLOSS (Soil Loss) An Interactive Model for Microcomputers

SLOSS (Soil Loss) An Interactive Model for Microcomputers

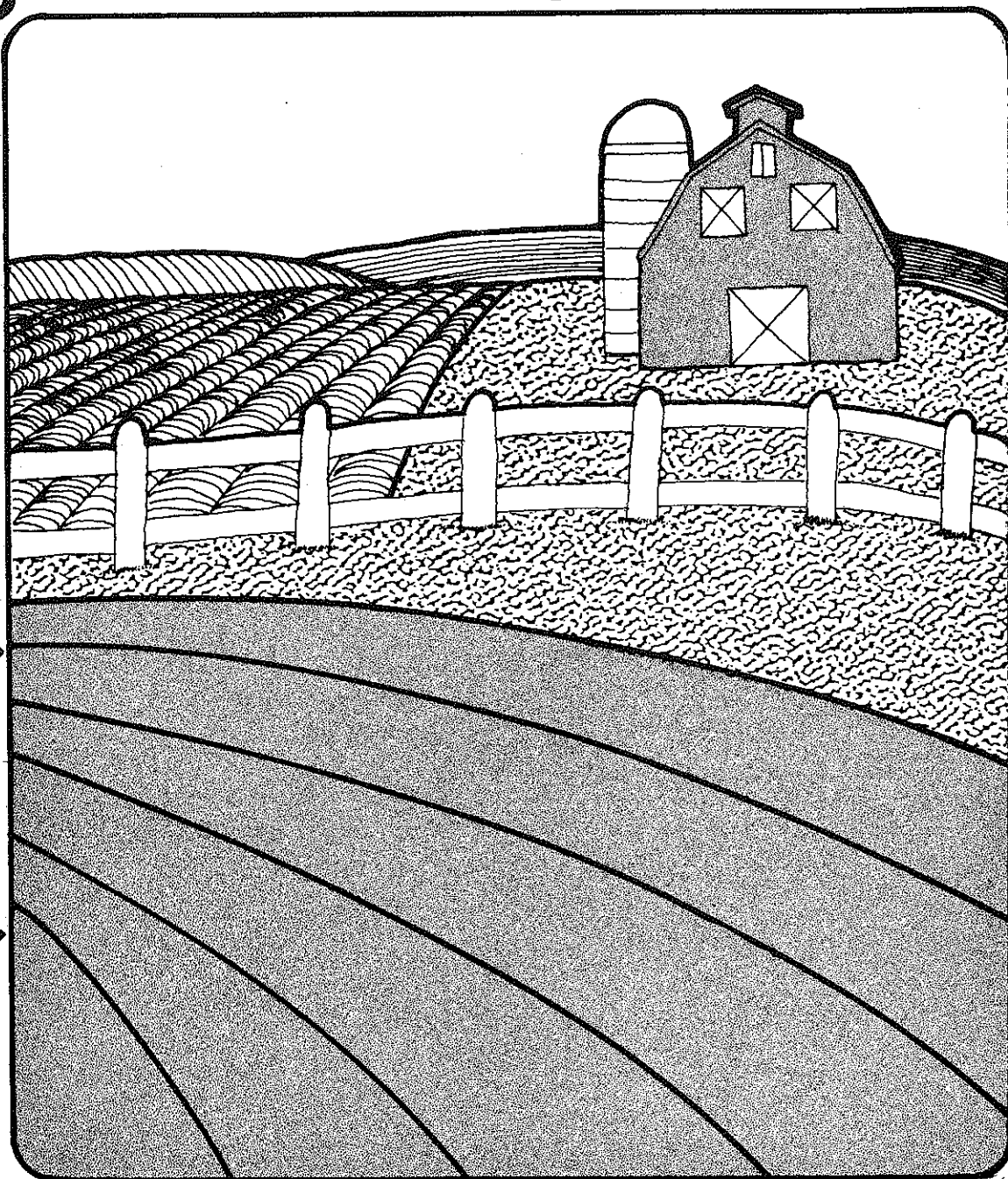

SLOSS (Soil Loss) An Interactive Model for Microcomputers

SLOSS (Soil Loss) An Interactive Model for Microcomputers

Louis Baumhardt, Anthony Trent and John C. Hayes

MAFES

MISSISSIPPI AGRICULTURAL & FORESTRY EXPERIMENT STATION
R. RODNEY FOIL, DIRECTOR **MISSISSIPPI STATE, MS 39762**

James D. McComas, President

Mississippi State University

Louis N. Wise, Vice President

SLOSS (Soil Loss)

An Interactive Model for Microcomputers

This report details the use of a soil-loss model for use on microcomputers. The model was developed to help extension, education and soil conservation personnel estimate the impact of various conservation treatments and for answering "what if?" questions about alternative combinations of soil conservation practices. The basis of the model is the USLE (Universal Soil-Loss Equation). The USLE is the most widely used soil-loss equation available. It encompasses the major factors pertaining to erosion in a relatively simple methodology. The SLOSS model is designed to assist in the application of the USLE by leading the user through a series of questions in an interactive program.

The model is "friendly" and will alert the user if inputs seem to be out of line. Accuracy is dependent on the completeness and correctness of each input, and inaccurate input data cannot be expected to yield useful results. SLOSS uses the lumped parameter approach so that inputs are minimal and cannot be expected to be as accurate as sophisticated modeling procedures, especially for unusual conditions. Each input is described, and examples of the procedures are included in this manual.

The USLE resulted from more than 10,000 plot years of data that related erosion rate to physical and management variables at each site. The SLOSS model is designed to estimate average annual soil loss resulting from a specific set of crop, soil, management and climatic conditions. The SLOSS model predicts the gross erosion from the field under consideration because it is based on the USLE. A short explanation of the terms in the equation is presented to assist the user in understanding the methodo-

logy. The user is referred to Wischmeier and Smith (1978) for additional information.

The Universal Soil-Loss Equation as given by Wischmeier and Smith (1978) is

$$A = RKLSCP$$

where

A = average annual soil loss (tons/acre)

R = rainfall runoff erosivity index

K = soil erodibility factor as average soil loss per unit of erosion index (R) for a particular soil as measured on a unit plot

LS = length-slope factor that accounts for topography

C = cover-management factor as the ratio of soil loss from an area with specified cover and management to an identical area in tilled continuous fallow

P = practice factor as the ratio of soil loss with conservation practices like contouring, strip-cropping or terracing to that of up-and-down-slope farming.

The significance of each factor will be discussed because selection of practices by the user is dependent on a general knowledge of the principles and factors on which the equation is based.

Rainfall-Runoff Erosivity Index (R)

The rainfall-runoff erosivity index accounts for the interrelationship of the erosion forces of falling rain and those of flowing water (runoff). Wischmeier (1959) analyzed momentum, kinetic energy, maximum 30-minute intensity, drop diameter, drop velocity and interactions of

these characteristics. This evaluation showed that the product of rainfall energy and the maximum 30-minute intensity was the best indicator of rainfall erosivity. The combination of two terms indicates the combined effects of particle detachment and flow transport. These factors are important because detachment and transport must occur for soil loss to take place. Thus the rainfall-runoff erosivity index for a single storm could be calculated using

$$R = EI_{30/100}$$

where

R = rainfall-runoff erosivity index

E = kinetic energy (foot-ton/acre-inch)

I = maximum 20-minute intensity (inches/hour).

The factor 100 is used to obtain a more manageable fraction. Wischmeier (1959) found that the kinetic energy of rainfall could be expressed as

$$E = 916 + 331 \log_{10} I$$

where

E = kinetic energy,

I = intensity.

One does not have to estimate rainfall intensity and energy to calculate R. An isoerodent map can be used to find local values for R. The map (Figure 1) is read as a topographic map is read except that the isoerodents are lines of constant erosion index rather than contour lines. Values are interpolated for locations between the lines. As indicated, the R-factor is based on geographical location. Figure 1 shows average annual R-factors. Soil loss for periods other than a calendar year also can be computed by adjusting the R-factor. This procedure will be illustrated later.

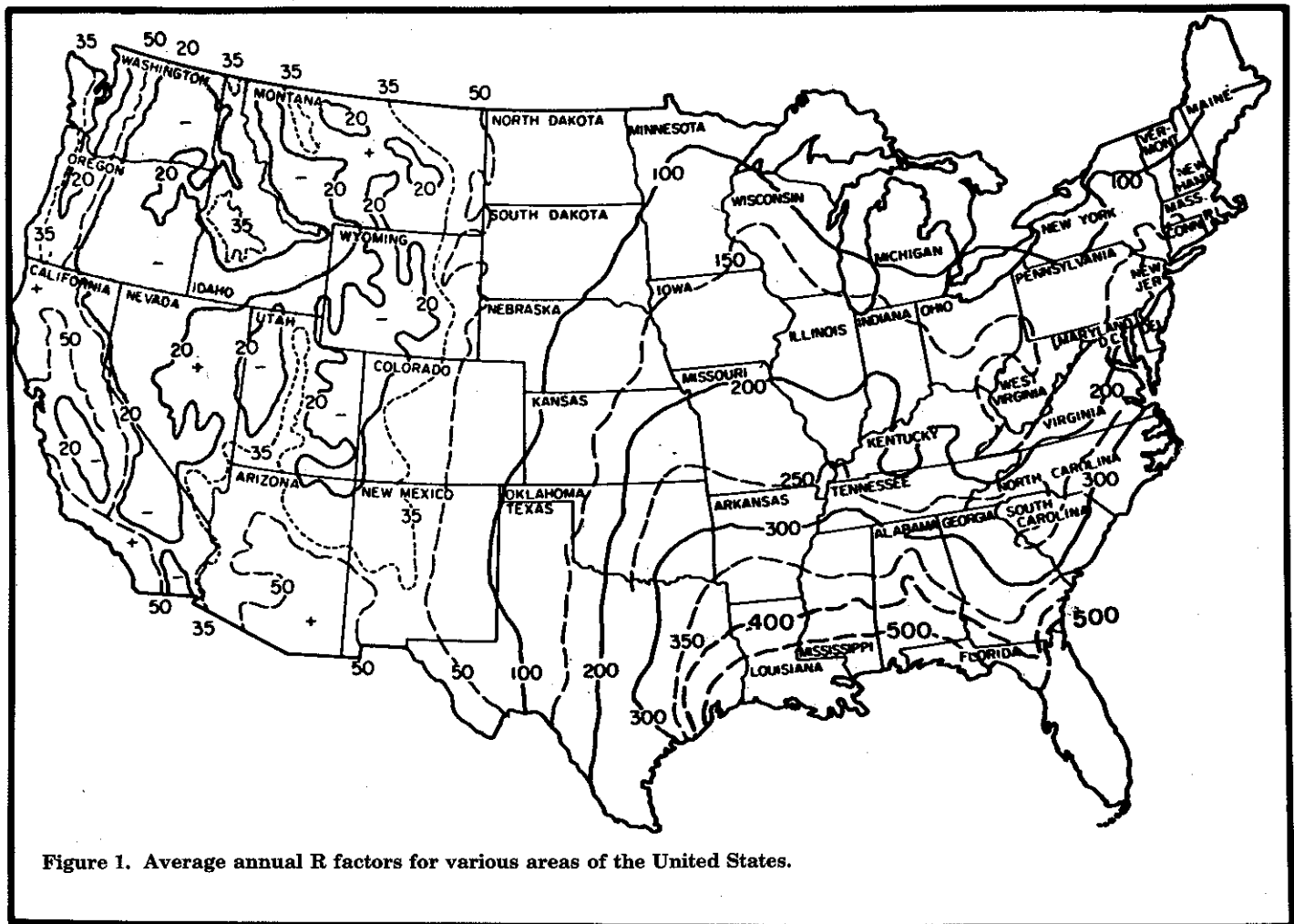

Figure 1. Average annual R factors for various areas of the United States.

Soil Erodibility Factor (K)

The soil erodibility factors (K) used in the USLE and in the SLOSS model are based on quantitative, experimentally determined values obtained from direct soil-loss measurements. The K-factor attempts to account for the susceptibility of a soil to erosion. It includes the interrelated effects of the resistance of a soil to detachment by rainfall and flowing water together with the soil's infiltration characteristics. Some selected soil erodibility factors, such as soil texture and organic matter (Schwab, et al.), are included (Table 1).

More accurate values for local soil types may be available from the Soil Conservation Service or other agencies. Wischmeier, et al. (1971) developed the nomograph

(Figure 2) that can be used to find the K-factor of other conditions. Note that, if information about the permeability and soil structure is not available, a first approximation of K is based on textural information and percent organic matter only. More recent studies on high-clay subsoils have found much higher erodibility factors than those found using the nomograph shown in Figure 2 (Barfield, et al., 1981).

The K-factor takes into account only soil characteristics. The effects of tillage, cover and management will be considered in other factors.

Length-Slope Factor (LS)

The length-slope factor (LS) accounts for the effect of topography on soil loss. Originally, the plots used in the development of the

USLE were 72.6 ft long on a 9% slope. In the development of the USLE, these conditions were given an LS value of unity (LS = 1.0). Other LS factors are ratios of soil loss at specified lengths and slopes to the standard of 72.6 ft and 9%. Slope length is the distance between the point where overland flow begins and the downslope point where deposition occurs or the flow enters a defined channel. An LS nomograph was developed by the Soil Conservation Service (1977) for uniform slopes. The nomograph (Figure 3) developed by Wischmeier and Smith (1978) simplifies the estimation of the length-slope factor. SLOSS will compose LS after the user enters the slope length and percent slope of the field.

Table 1. Selected Soil Erodibility Factors (K) by soil Texture.

Textural Class	Organic Matter Content (%)		
	0.5	2	4
Fine sand	0.16	0.14	0.10
Very fine sand	0.42	0.36	0.28
Loamy sand	0.12	0.10	0.08
Loamy fine sand	0.44	0.38	0.30
Sandy loam	0.27	0.24	0.19
Very fine sandy loam	0.47	0.41	0.33
Silt loam	0.48	0.42	0.33
Clay loam	0.28	0.25	0.21
Silty clay loam	0.37	0.32	0.26
Silty clay	0.25	0.23	0.19

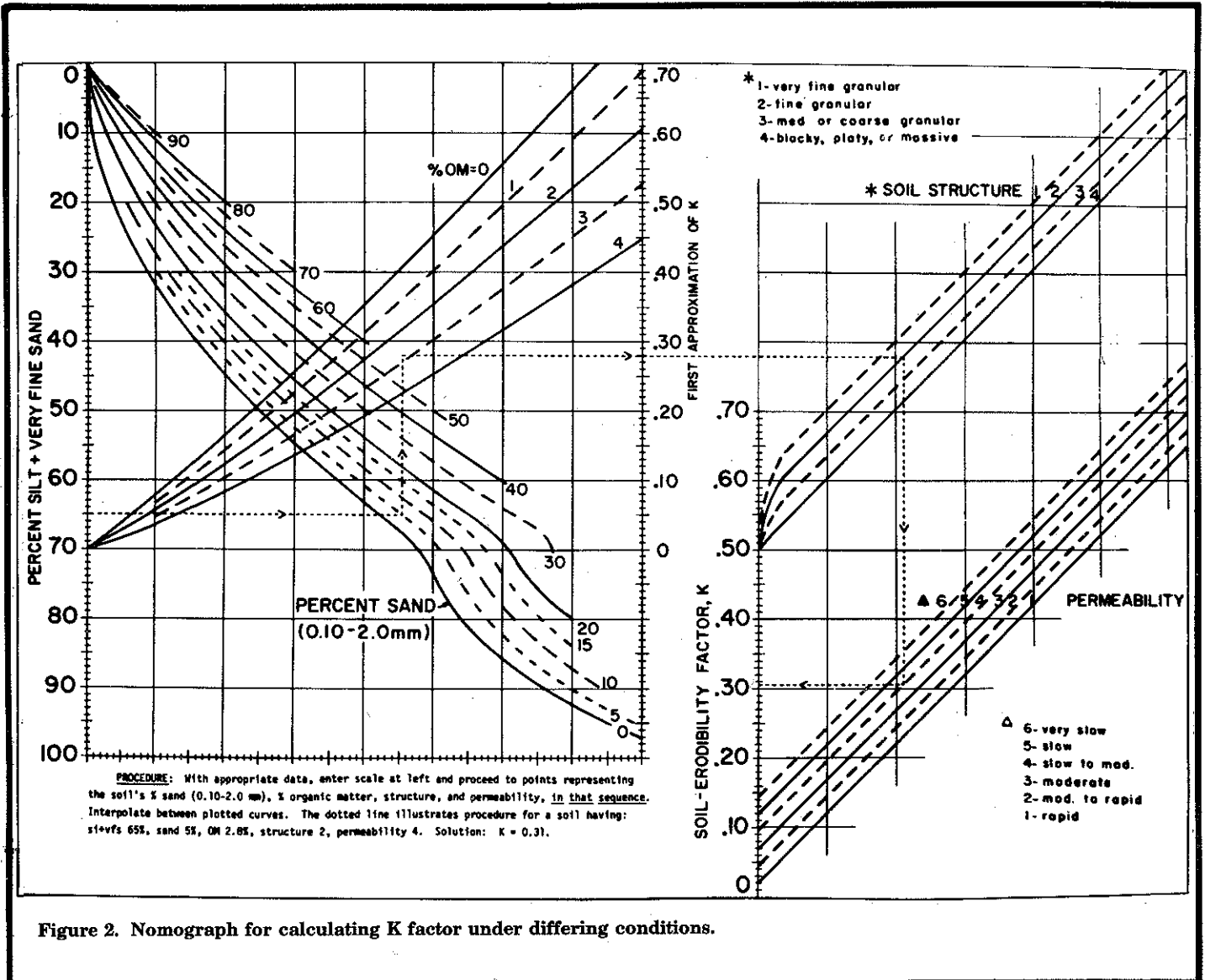

Figure 2. Nomograph for calculating K factor under differing conditions.

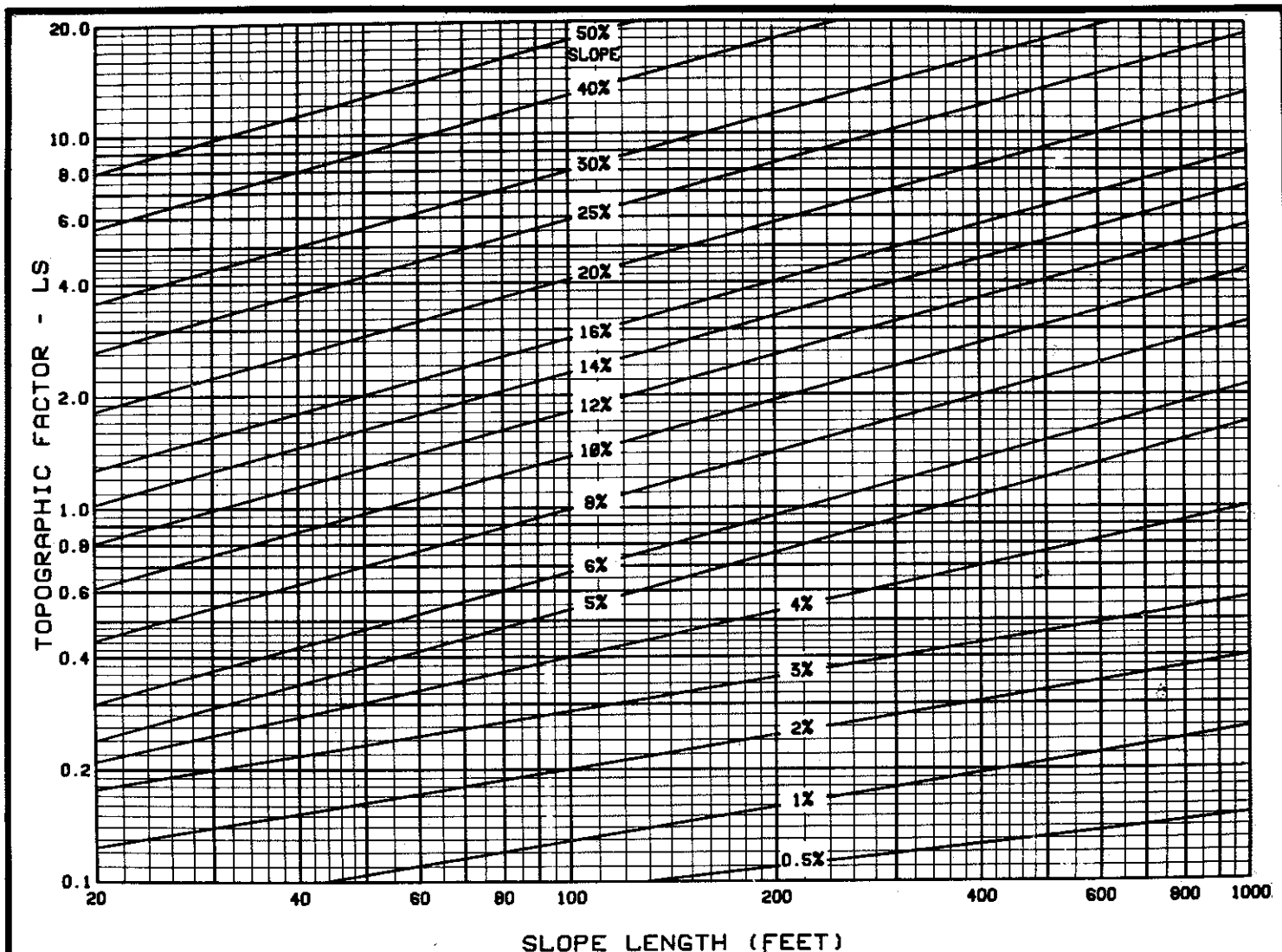

Figure 3. A nomograph which simplifies estimation of the length-slope factor.

Cover-Management Factor (C)

The cover-management factor (C) considers the combined effects of cover, tillage practices, residue, crop sequencing and the anticipated time distribution of erosive rains. In USLE development, the C-factor was defined as unity for continuous fallow. The C-factor involves the variable in the USLE that can vary over the widest range for a specific location. For example, it can vary from about .01% for undisturbed woodland having complete ground cover and canopy closure to 100% for bare-fallow conditions. Values for the C-factor for the crop-stage period as a ratio of the soil loss for

crops to that of continuous fallow are presented in Table 2 for selected crop stages (Wischmeier and Smith, 1978). The time distribution of the rainfall-runoff erosivity index varies with geographic location.

The C-factor is typically expressed as an annual value for a particular cropping-management combination to simplify the soil-loss computations. Soil loss is dependent on cover and residue management because these affect the amount of protection provided the soil. Because the C-factor changes as a function of growth stage (Table 2) and rainfall energy and intensity patterns are not uniform throughout the year (Figure 4), crop-stage C-factors must

be weighted proportionally to the appropriate percentages of the average annual erosivity index (Table 3).

Accumulated percentages of the average annual R-factor as a function of time throughout the year (Table 4) for geographical areas in the eastern United States were determined from Figure 5 (Wischmeier and Smith, 1978). Similar information is available in the same reference for other crops and locations. SLOSS permits the option of entering the annual C-factor, computing a time-weighted C-factor that weights according to the proportion of the year and crop stage or computing an EI-S weight-

Table 2. Selected C-Factors from Cropland as a ratio percentage of the Corresponding Loss from Continuous Fallow (Wischmeier and Smith, 1978).

Crop Sequence and Tillage ^a	Spring residue Lb	Cover after plant %	C-factor for cropstage period ^b					
			F	SB	1	2	3	4
CORN AFTER C, GS, G or COT IN MEADOWLESS SYSTEMS								
Moldboard plow, conv. till:								
1. RdL, sprg TP	3,400	--	36	60	52	41	20	30
2. RdL, fall TP	GP	--	49	70	57	41	20	--
3. RdR, sprg TP	GP	--	67	755	66	47	23	62
4. RdR, fall TP	GP	--	77	83	71	50	23	--
5. No-till plant in crop residue	6,000	90	--	3	3	3	3	14
No-till plant in crop residue	3,400	70	--	8	8	8	6	19
CORN IN SOD-BASED SYSTEMS								
No-till pl in killed sod:								
6. 3 to 5 hay yld	--	--	--	1	1	1	1	1
Strip till, 1-2 meadow:								
7. 40% cover, tilled strips	--	--	--	4	4	4	4	6
CORN AFTER SOYBEANS								
8. Sprg, TP, conv till	GP	--	47	78	65	51	25	37
9. Fall TP, conv till	GP	--	53	81	65	51	25	--
10. Fall & Sprg chisel or cult	GP	25	--	45	39	33	23	37
11. No-till pl in crop res'd	GP	30	--	33	29	25	14	33
BEANS AFTER CORN								
12. Sprg, TP, RdL, conv till	GP	--	39	64	56	41	18	28
13. Fall TP, RdL, conv till	GP	--	52	73	61	41	18	46
GRAIN AFTER C, G, GS, COT								
14. Disked-in residues	3,400	60	--	16	14	12	2	30

PERMANENT MEADOW

^a Symbols: C - Corn; GS - Grain Sorghum; G - Small Grain; COT - Cotton; RdL - Residue left on field; RdR - Residue Removed; GP - Good Productivity; TP - Turnplow; F - Fallow; SB - Seedbed

Period F (rough Fallow) - Inversion plowing to secondary tillage.

Period SB (seedbed) - Secondary tillage for seedbed preparation until the crop has developed 10 percent canopy cover.

Period 1 (establishment) - End of SB until crop has developed a 50 percent canopy cover. (Exception: Period 1 for cotton ends at 35 percent canopy cover.)

Period 2 (development) - End of Period 1 until canopy cover reaches 75 percent.

Period 3 (maturing crop) - End of Period 2 until crop harvest. This period was evaluated for three levels of final crop canopy.

Period 4 (residue or stubble) - Harvest to plowing or new seeding.

- (1) Periods selected to coincide with cropstage periods used in Table 2.
- (2) Dates for each cover condition in column (1).
- (3) Percentages of cumulative R (Table 3) at end of interval in column (2).
- (4) Incremental differences between values in column (3).
- (5) Percentage of C-factor for cropstage period indicated in column (1) taken from Table 2.
- (6) Product of column (4) and column (5). The sum of column (6) is the average annual C-factor.

ed C-factor that weights accordings to EI distribution and crop stage. An example of the procedure the computer uses to compute the time-weighted C-factor will suffice to illustrate the use of the charts to obtain an average annual C.

Example 1.

Calculate the average annual C-factor for continuous corn with the following data specified: The corn is grown near Starkville, Mississippi (geographical area 22, from Figure 5),

turnplowed - March 1; disked - April 1; planted - April 15; harvested - September 1. Assume that the residue is left on the field. (See table 3 for solution.)

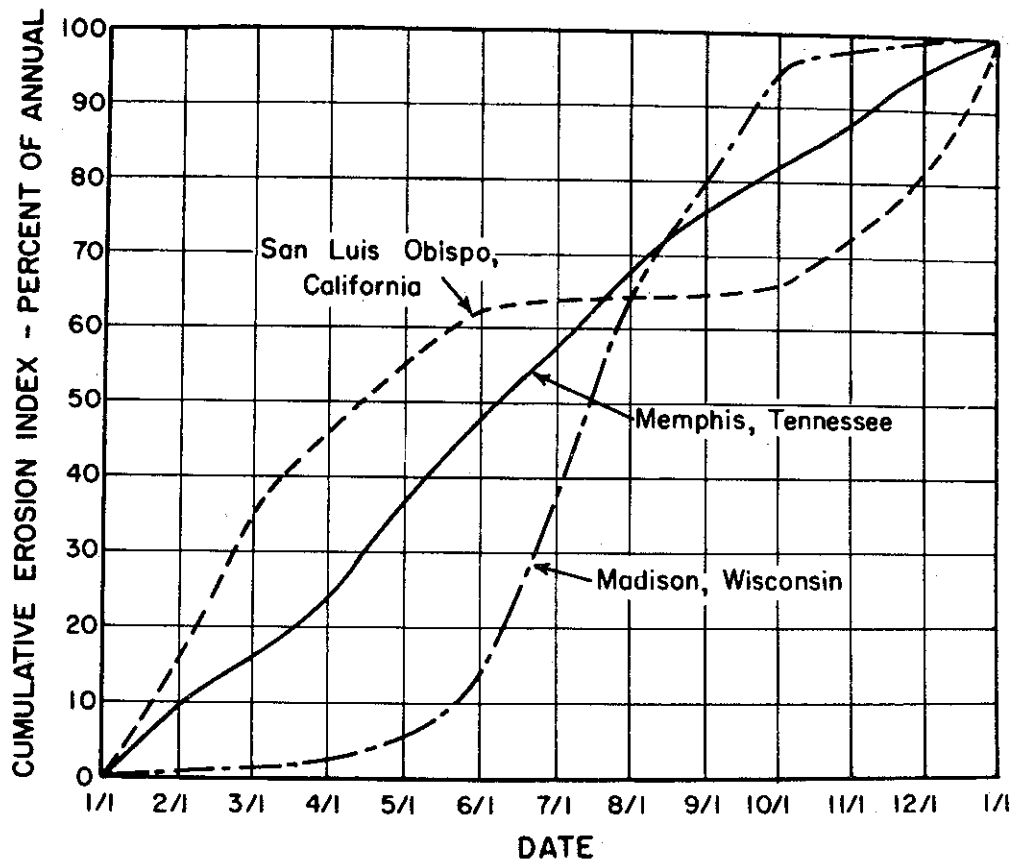

Figure 4. Cumulative erosivity index reveals non-uniform rainfall patterns.

Table 3. Calculated C factors for continuous corn, by periods.¹

Period ¹	Dates ²	% of Cum. R ³	Incr. % of R. ⁴	C-factor for Stage (%) ⁵	C for Incr ⁶
Residue (4)	1/1-3/1	13	13	30	0.0390
Fallow (F)	3/1-4/1	21	8	36	.0288
Seedbed (SB)	4/1-5/15	38	17	60	.1020
Establishment (1)	5/15-7/1	55	17	52	.0884
Development (2)	7/1-8/8	67	12	41	.0492
Maturing Crop (3)	8/1-9/1	75	8	20	.0160
Residue (4)	9/1-12/31	100	25	30	.0750

= 0.3984

Average Annual C = 0.40 = 40%

¹Periods selected to coincide with cropstage periods used in Table 2.

²Dates for each cover condition in column (1).

³Percentages of cumulative R (Table 3) at end of interval in column (2).

⁴Incremental differences between values in column (3).

⁵Percentage of C-factor for cropstage period indicated in column (1) taken from Table

⁶Product of column (4) and column (5). The sum of column (6) is the average annual C-factor.

Practice Factor (P)

The conservation-practice factor (P) in the USLE represents the ratio of soil loss with a specified practice to the corresponding loss with up-and-down-slope farming, which has a P-factor of unity (P =

1.0). The practice factor reflects the influence of contour tillage, strip-cropping along the contour and terrace systems. These practices tend to disturb the overland flow of runoff so that large quantities of

water do not cause movement of large amounts of soil. Recommended P-factors for various conditions are shown in Table 5 (Wischmeier and Smith, 1978).

Table 4. Accumulated Percentage of the Average Annual R between January 1 and Specified Date (Wischmeier and Smith, 1978).

Area No.	JAN.		Feb.		Mar.		Apr.		May		June		July		Aug.		Sept.		Oct.		Nov.		Dec.	
	1	15	1	15	1	15	1	15	1	15	1	15	1	15	1	15	1	15	1	15	1	15	1	15
1	0	0	0	0	0	0	1	2	3	6	11	23	36	49	63	77	90	95	98	99	100	100	100	100
2	0	0	0	0	1	1	2	3	6	10	17	29	34	55	67	77	85	91	96	98	99	100	100	100
3	0	0	0	0	1	1	2	3	6	13	23	37	51	61	69	78	85	91	94	96	98	99	99	100
4	0	1	1	1	2	3	4	7	12	18	27	38	48	55	62	69	76	83	90	94	97	98	99	100
5	0	3	2	3	4	6	8	13	21	29	37	46	54	60	65	69	74	81	87	92	95	97	98	99
6	0	0	0	0	1	1	1	2	6	16	29	39	46	53	60	67	74	81	88	95	99	99	100	100
7	0	2	1	2	3	4	6	8	12	25	40	49	56	62	67	72	76	80	85	91	97	98	99	99
8	0	5	3	5	7	10	14	20	28	37	48	56	61	64	68	72	77	81	86	89	92	95	98	99
9	0	6	4	6	9	12	17	23	30	37	43	49	54	58	62	66	70	74	78	82	86	90	94	97
10	0	1	2	4	6	8	10	14	21	29	38	47	53	57	61	65	70	76	83	88	91	94	96	98
11	0	1	3	5	7	9	11	15	18	27	35	41	46	51	57	62	68	73	79	84	89	93	96	98
12	0	0	0	0	1	1	2	3	5	9	15	27	38	50	62	74	84	91	95	97	98	99	99	100
13	0	0	0	1	1	2	3	5	7	12	19	33	38	57	65	74	82	88	93	96	98	99	100	100
14	0	0	0	1	2	3	4	6	9	14	20	28	39	52	63	72	80	87	91	94	97	99	99	100
15	0	0	1	2	3	4	6	8	11	15	22	31	40	49	59	69	78	85	91	94	96	98	99	100
16	0	1	2	3	4	6	8	10	14	18	25	34	45	56	64	72	79	84	89	92	95	97	98	99
17	0	1	2	3	4	5	6	8	11	15	20	28	41	54	65	74	82	87	92	94	96	97	98	99
18	0	1	2	4	6	8	10	13	19	26	34	42	50	58	65	68	74	79	84	89	93	95	97	99
19	0	1	3	6	9	12	16	21	26	31	37	43	50	57	64	71	77	81	85	88	91	93	95	97
20	0	2	3	5	7	10	13	16	19	33	27	34	44	54	63	72	80	85	89	91	93	95	96	98
21	0	3	6	10	13	16	19	23	26	29	33	39	47	58	68	75	80	83	86	88	90	92	95	97
22	0	3	6	9	13	17	21	27	33	38	44	49	55	61	67	71	75	78	81	84	86	90	94	97
23	0	3	5	7	10	14	18	23	27	18	35	39	45	53	60	67	74	80	84	86	88	90	93	95
24	0	3	6	9	12	16	20	24	28	33	38	43	50	59	69	75	80	84	87	90	92	94	96	98
25	0	1	3	5	7	10	13	17	21	24	27	33	40	46	53	61	69	78	89	92	94	95	97	98
26	0	2	4	6	8	12	16	20	25	30	35	41	47	56	57	75	81	85	87	89	91	93	95	97
27	0	1	2	3	5	7	10	14	18	22	27	32	37	46	58	69	80	89	93	94	95	96	97	99
28	0	1	3	5	7	9	12	15	18	21	25	29	36	45	56	68	77	83	88	91	93	95	97	99
29	0	1	2	3	4	5	7	9	11	14	17	22	31	42	54	65	74	83	89	92	95	97	98	99
30	0	1	2	3	4	5	6	8	10	14	19	26	34	45	56	66	76	82	86	90	93	95	97	99
31	0	0	0	1	2	3	4	5	7	12	17	24	33	42	55	67	76	83	89	92	94	96	98	99
32	0	1	2	3	4	5	6	8	10	13	17	22	31	42	52	60	68	75	80	85	89	92	96	98
33	0	1	2	4	6	9	11	13	15	18	21	26	32	38	46	55	64	71	77	81	77	81	93	97

Table 5. Practice Factors (P).

Percent slope	P contouring	P strip crop	Graded channels	Steep back
	(max. slope length)	(max. strip width)	sod outlets	underground outlet
1-2	.60 (400)	.45 (800)	.12	.05
3-8	.50 (300)	.30 (600)	.10	.05
9-12	.60 (120)	.45 (240)	.12	.05
13-16	.70 (80)	.52 (160)	.14	.05
17-20	.80 (60)	.60 (120)	.16	.06

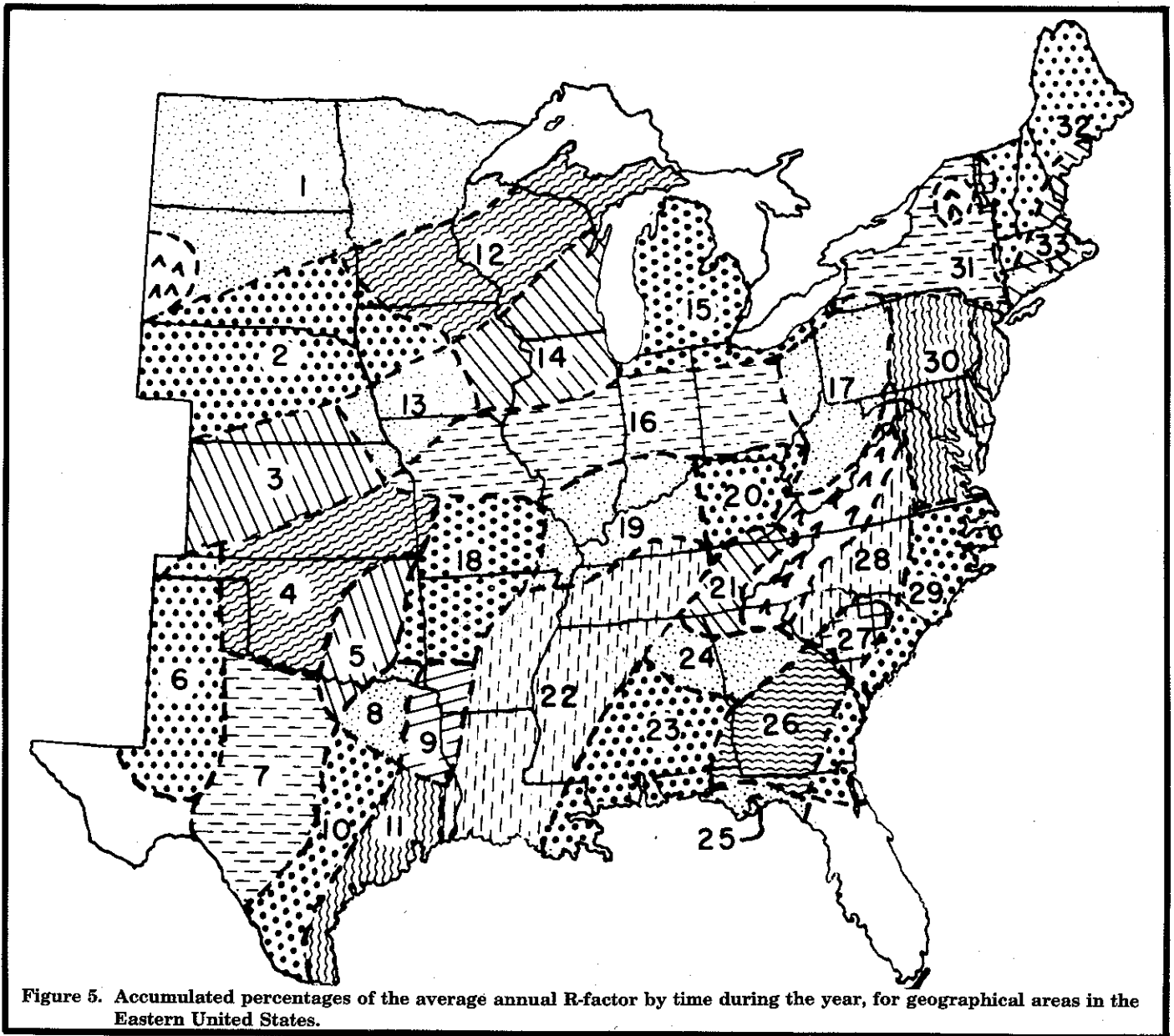

Figure 5. Accumulated percentages of the average annual R-factor by time during the year, for geographical areas in the Eastern United States.

Organization and Features

SLOSS begins operation by printing some initial statements and prompting the user to declare the number of fields to be considered (Figure 6-A). Calculation of soil loss from multiple fields permits convenient comparison of two or more management schemes from the standpoint of erosion control. An areal weighted average will be computed from the soil loss of all fields considered for use as a baseline mean-annual soil-loss value. A

help routine (Figure 6-E) is accessible from any prompted input that provides an explanation of the prompted input term where the "Help" request originates throughout SLOSS.

Once the number of fields has been declared, SLOSS obtains K, P, L and S values for each field (Figure 6-B). Inputs for K and P are checked for conformity to published and nomograph-derivable values. If values deviate from the normal

range, the user is warned and prompted for another value. The program aborts operation if three incorrect K values are entered. This feature may help people who are not familiar with the USLE. All entered values are displayed for subsequent editing (if needed) following the entry of the last variable from the last field (Figure 6-C).

SLOSS collects C and R values after the field data have been edited. The three methods permitted for

evaluating C and R (Figure 6-D) are (1) simple single annual C and R value, (2) time-weighted C and R value and (3) EI-weighted C with R value. The user chooses the method for entering C and R data on a by-field basis. Editing of input data is permitted before the field counter is advanced.

When all fields have been assign-

ed appropriate C and R values soil loss in tons per acre per year is displayed for each field, with the mean soil loss for all the fields combined. A hard (printed) copy of all terms and the computed soil-loss rate can be obtained. Additional computation may be initiated (Figure 6-F), with the option to edit the old field data set, go to C, begin

with a totally new field data set or go to A. If no further computations are wanted the program terminates accordingly. Improper responses to input prompts may terminate or extend program execution; therefore, it is imperative to *READ* the prompts.

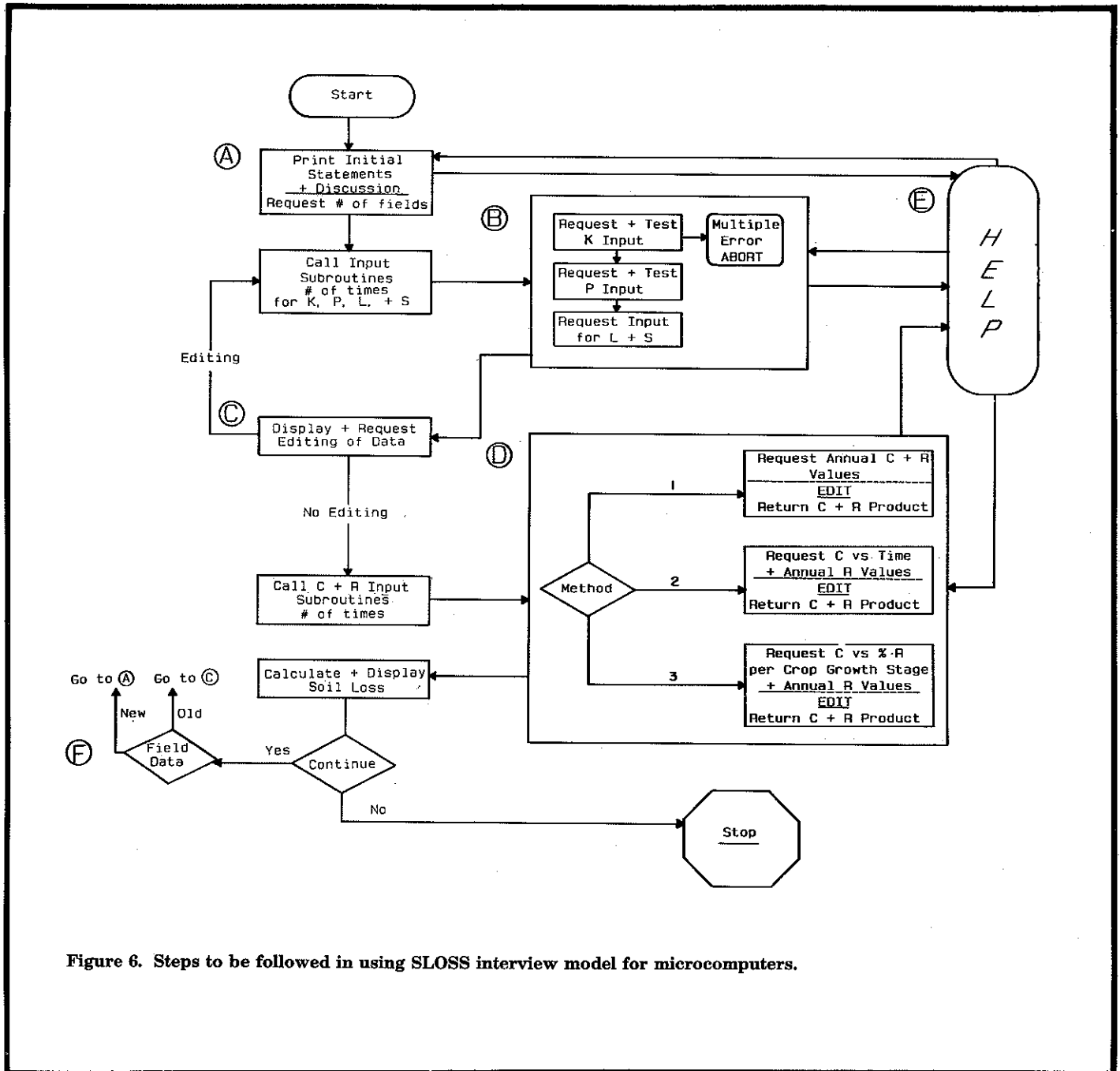

Figure 6. Steps to be followed in using SLOSS interview model for microcomputers.

OPERATIONAL EXAMPLES

The examples that follow should aid the user in further understanding the use of the soil-loss factors used in the USLE and the operation of SLOSS. The examples use the interactive feature of the SLOSS model to illustrate user program operation.

Example 2a

Given a 70-acre field located near Memphis, Tennessee, calculate the average annual soil loss per year while implementing the following cropping system:

Crop - continuous corn; turn-plowed March 9, Seedbed April 15, Harvested September 1 and crop residue left on the field.

Field Length - 300 feet; field slop 10%.

Soil conditions - 65% silt and fine sand, 5% sand, 3% organic matter and fine grained, moderately drained.

Plowed up-and-down slope.

Based upon the given conditions, R=310 (Figure 1), K=.27 (Figure 2) and LS=2.4 (Figure 3), the user enters a slope of 10% and a field length of 300 feet. The model determines the LS-factor, C=4 (using the average annual C from Example 1) and P=1 from Table 5. Using the USLE (A=RKLSCP), the average annual soil loss from this field is about 80 tons per acre.

The following illustrates the same example with user inputs and model responses and results:

RUN

Agronomy and Agricultural Engineering Departments

Mississippi State University

1983

Louis Baumhardt - Tony Trent

John C. Hayes

<Depress Any Key To Start Program>

This Program estimates SOILLOSS from a field using the UNIVERSAL SOIL LOSS EQUATION. If you are not familiar with the Universal

Soil Loss Equation - STOP and read the manual that came with this program. If you have read the manual and are ready to proceed - <Depress Any Key To Continue> -
-R-E-M-E-M-B-E-R-

This program ESTIMATES soil loss and depends upon the correctness of the information that you enter. If you start and need HELP at any time just type the word 'HELP' <ENTER> and assistance will be provided. If you are ready we will get started. <Depress any key>. We can look at all or just some of the fields that make up a farm.

How many fields do you want to consider? (10 max)

? 1

How many acres in Field- 1

? 70

Enter the Soil Erodibility Factor (K) for the soil in field- 1

? .27

What is the Conservation Practice Factor (P) for Field- 1

? 1.0

What is the % Slope for Field- 1

? 10

Enter the length of the slop- in FEET

? 300

FIELD DATA EDITOR

Field ACRES K P Slope Length
1 70 .27 1 10 300

Any changes- YES or NO ?

? NO

CROP COVER FACTOR METHODS:

1. Unweighted

2. Weighted

3. Weighted Rainfall Erosivity Factor (R)

Field- 1

Method+ ? 1

Enter Crop Cover Factor (%)? 40

Crop Cover Factor- Field 1 = 40

CHANGE-YES or NO

? NO

Enter Rainfall Erosivity Factor (R)?

310

SOIL LOSS

Field	Soil Loss (Tons/Acre)
1	79.443

<Depress -H- for hard copy or -C- to continue>

FIELD	Acres	K	P	=Slope	Length-	C	R	Soil Loss
1	70	.27	1	10	300	40	310	79.43

Another Problem-YES or NO

Example 2b

Using the same field, calculate the average annual C-factor and average annual soil loss for the following system:

Crop - corn after soybeans, with spring TP and conventional tillage and contour plowing

From previous and given conditions, R=310, P=.6 (Table 5), LS=2.4 and K=.27. The EI weighted C-factor will be determined by the model using the time-distribution of rainfall-runoff erosivity index and the corresponding C-factor as illustrated by the following user inputs in columns (3) and (5) in Table 4 (geographical area 22 from Figure 5).

(1)	(2)	(3)	(4)	(5)	(6)
Period	Dates	%of CumR	Incr. % ofR	C-factor for Stage %	C for Incr.
Residue	1/1-3/1	13	13	37	.0481
Fallow (F)	3/1-4/1	21	8	47	.0376
Seedbed (SB)	4/1-5/1	33	12	78	.0936
Establishment (1)	5/1-6/15	49	16	65	.1040
Development (2)	6/15-8/1	67	18	51	.0918
Maturing Crop (3)	8/1-9/15	78	11	25	.0275
Residue (4)	9/15-12/31	100	22	37	.0814

Average annual C = .46 = 46%

Another Problem-YES or NO

? YES

CHOOSE ONE

1. New Field Data Set

2. Modify Existing Field Data Set

<2>

FIELD DATA EDITOR

Field ACRES K P Slope Length
1 70 .27 1 10 300

Any changes- YES or NO ?

? YES

In which Field? ? 1

Which Factor? P

Field- 1 P = 1

Enter new value

? .6

FIELD DATA EDITOR

Field ACRES K P Slope Length
1 70 .27 .6 10 300

Any changes- YES or NO ?
? NO

CROP COVER FACTOR METHODS:

- 1. Unweighted
- 2. Weighted
- 3. Weighted Rainfall Erosivity Factor (R)

Field- 1
Methods= ? 3
This method calculates soil loss based on time periods. More than one time period may be entered. Time periods must be entered in sequence from earliest to latest.

Enter the beginning date of the first time period- MM/DD/YY
? 01/01/83

Ending Date Time Period- 1
? 03/01/83

Enter the Crop Cover Factor % for this period? 37

Another Time Period- YES or NO ?
YES

Ending Date Time Period- 2
? 04/01/83

Enter the Crop Cover Factor for this period? 47

Another Time Period- YES or NO ?
YES

Ending Date Time Period- 3
? 05/01/83

Enter the Crop Cover Factor for this period? 78

Another Time Period- YES or NO ?
YES

Ending Date Time Period- 4
? 06/15/83

Enter the Crop Cover Factor for this period? 65

Another Time Period- YES or NO ?
Yes

Ending Date Time Period- 5
? 08/01/83

Enter the Crop Cover Factor for this period? 51

Another Time Period- YES or NO ?
YES

Ending Date Time Period- 6
? 09/15/83

Enter the Crop Cover Factor for this period? 25

Another Time Period- 7
? 12/31/83

Enter the Crop Cover Factor for this period? 37

Another Time Period- YES or NO ?
NO

Initial Time - 01/01/83

FIELD- 1

Time	Date	Cover Factor%
1	03/01/83	37
2	04/01/83	47
3	05/01/83	78
4	06/15/83	65
5	08/01/83	51
6	09/15/83	25
7	12/31/83	37

Any Changes - YES or NO
? NO

Enter Rainfall Erosivity Factory (R)?
310

Rainfall Erosivity Factor (R) = 310
Initial Time- 01/01/83

Input Initial % R Accumulated?
Time Date Cover Factor%

1 03/01/83 37
Enter % of R accumulated by Date? 13

2 04/01/83 47
Enter % of R accumulated by Date? 21

3 5/01/83 78
Enter % of R accumulated by Date? 33

4 06/15/83 65
Enter % of R accumulated by Date? 49

5 08/01/83 51
Enter % of R accumulated by Date? 67

6 09/15/83 25
Enter % of R accumulated by Date? 78

7 12/31/83 37
Enter % of R accumulated by Date? 100

Rainfall Erosivity Factor = 310

Time	Date	C	%R
1	03/01/83	37	13
2	04/01/83	47	21
3	05/01/83	78	33
	06/15/83	65	49
5	08/01/83	51	67
6	09/15/83	25	78
7	12/31/83	37	100

Any changes- YES or NO ?
? NO

Field	Soil Loss (Tons/Acre)
	57.67

<Depress -H- for hard copy or -C- to continue>

FIELD	Acres	K	P	Slope	Length	C	R	Soil Loss
1	70	.27	.6	10	300	48	310	57.67

Another Problem- YES or NO
Example3

Determine the average annual soil loss from two fields located near Des Moines, Iowa, with the following conditions:

Field 1	Field 2
30 acre	55 acres
Permanent pasture	Permanent pasture
Field length - 800 feet	Field length - 1,000 feet
Field slope - 8%	Field slope - 2%
Soil - silty clay loam .5% o.m.	Soil - very fine sandy loam 4% o.m.
Field is contour terraced with previously established terraces in corn with 200 feet between terraces	Field is contour terraced (same as Field 1)

From the given conditions the soil loss factors were determined for each field.

Field 1	Field 2
R = 170 (Figure 1)	R = 170 (Figure 1)
C = .4% (Table 2)	C = .4% (Table 2)
L = 200 feet	L = 200 feet
S = 8%	S = 2%
K = .27 (Table 1)	K = .33 (Table 1)
P = .10 (Table 5)	P = .12 (Table 5)

It should be noted that the slope length entered by the user is the length between terraces and not the length of the field. By comparison if the field was not terraced, the field length should be entered along with a new P-factor.

Another Problem- YES or NO
? YES

CHOOSE ONE

- 1. New Field Data Set
- 2. Modify Existing Field Data Set

<2>

We can look at all or just some of the fields that make up a farm.

How many fields do you want to look at? (10 max)

? 2

How many acres in Field- 1
? 30

Enter the Soil Erodibility Factor (K) for the soil in field- 1

? .37

What is the Conservation Practice Factor (P) for Field- 1

? .1

What is the % Slope for field- 1
 ? 8
 Enter the length of the slope- in
 FEET
 ? 200
 How many acres in Field- 2
 ? 55
 Enter the Soil Erodibility Factor
 (K) for the soil in field- 2
 ? .33
 What is the Conservation Practice
 Factor (P) for Field- 2
 ? .12
 What is the % Slope for Field- 2
 ? 2
 Enter the length of the slope- in
 FEET
 ? 200

FIELD DATA EDITOR

Field	ACRES	K	P	Slope	Length
1	30	.37	.1	8	200
2	55	.33	.12	2	200

Any changes- YES or NO ?
 ? NO

CROP COVER FACTOR METHODS:

1. Unweighted
 2. Weighted
 3. Weighted Rainfall Erosivity
 Factor (R)
 Field- 1
 Methods = ? 1
 Enter Crop Cover Factor % ? .4
 Crop Cover Factor- Field 1 = .4
 Changes- YES or NO
 ? NO
 Enter Rainfall Erosivity Factor (R)?
 170

CROP COVER FACTOR METHODS:

1. Unweighted
 2. Weighted
 3. Weighted Rainfall Erosivity
 Factor (R)
 Field- 2
 Method = ? 1
 Enter Crop Cover Factor? .4
 Crop Cover Factor- Field 2 = .4
 CHANGES- YES or NO
 ? NO

Enter Rainfall Erosivity Factor (R)
 ? 170

SOIL LOSS

Field	Soil Loss (Tons/Acre)
1	0.04
2	0.01

Total Soil Loss = .477855 Tons/Acre
 <Depress -H- for hard cropy or -C- to
 continue>

FIELD	Acres	K	P	Slope	Length	C	R	Soil Loss
1	30	.37	.1	8	200	.4	170	0.04
2	55	.33	.12	2	200	.4	170	0.01

Total Soil Loss- 0.02 Ton per Acre
 Another Problem- YES or No
 ?

Comparison of the three previous examples should illustrate the wide range of soil loss values resulting from changing the C and P factors. As mentioned previously, the results are only as good as the input data used and the data must accurately reflect the cropping and management systems.

REFERENCES

1. Barfield, B. J., R. C. Warner, and C. T. Haan. 1981. Applied Hydrology and Sedimentology for Disturbed Areas. Oklahoma Technical Press, Stillwater, Oklahoma.
2. Schwab, G. O., R. K. Frevert, T. W. Edminster, and K. K. Barnes. 1981. Soil and Water Conservation Engineering. Third edition. John Wiley & Sons, New York.
3. Soil Conservation Service. 1977. Procedure for Computing Sheet and Rill Erosion on Project Areas. Technical Release 51, USDA-SCS, Washington, D.C.
4. Wischmeier, W. H. 1959. A Rainfall Erosion Index for a Universal Soil Loss Equation. Soil Science Society of America Proceedings 23:246-249.
5. Wischmeier, W. H., C. B. Johnson, and B. V. Cross. 1971. A soil erodibility Nomograph for Farmland and Construction Sites. Journal of Soil and Water Conservation 26(5):189-193.
6. Wischmeier, W. H. and D. D. Smith. 1978. Predicting Rainfall Erosion Losses - A Guide to Conservation Planning. U. S. Department of Agriculture, Agriculture Handbook No. 537.

Editor's note: To obtain copies of the program described in this publication, write Mississippi Cooperative Extension Service, Mississippi State University, Mississippi State, MS 39762—attention Computer Applications and Service.

Mention of a trademark or proprietary product does not constitute a guarantee or warranty of the product by the Mississippi Agricultural and Forestry Experiment Station and does not imply its approval to the exclusion of other products that also may be suitable.

Mississippi State University does not discriminate on the basis of race, color, religion, national origin, sex, age, or handicap.

In conformity with Title IX of the Education Amendments of 1972 and Section 504 of the Rehabilitation Act of 1973, Joyce B. Giglioni, Assistant to the President, 610 Allen Hall, P. O. Drawer J, Mississippi State, Mississippi 39762, office telephone number 325-3221, has been designated as the responsible employee to coordinate efforts to carry out responsibilities and make investigation of complaints relating to discrimination.