

Pruning and Maintenance of Commercial Vineyards

MAFES
Mississippi Agricultural &
Forestry Experiment Station
R. Rodney Foil, Director

Mississippi State University, Mississippi State, MS39762

MCES
Mississippi Cooperative
Extension Service
James R. Carpenter, Director

Acknowledgement

The authors acknowledge with appreciation the reviews by

Steve Windham, Superintendent, MAFES Truck Crops Branch

W. O. Thomas (Deceased), Former Horticulturist, MAFES Truck Crops Branch

R. C. Albritton, Superintendent, MAFES Northeast Mississippi Branch

Boyette Graves, Horticulturist, Vegetable Unit, MAFES South Mississippi Branch

J. P. Overcash (Retired), Horticulturist, Mississippi State University, Department of Horticulture

Fred Shuman, Professor and Agricultural Engineer, Mississippi State University, Department of Agricultural and Biological Engineering

Boris Stojanovic, Professor and Head, Mississippi State University, A. B. McKay Food and Enology Laboratory

Richard P. Vine, Cellar Master, Mississippi State University, A. B. McKay Food and Enology Laboratory

J. R. Clark, Resident Director, University of Arkansas, Fruit Substation, Clarksville, Arkansas

Milo Burnham, Horticulturist, Mississippi Cooperative Extension Service, Mississippi State University

whose comments and suggestions contributed appreciably to improvement of this publication.

Establishment and Maintenance of Muscadine Vineyards

C. P. Hegwood, Horticulturist, MAFES
Truck Crops Branch

R. H. Mullenax, Horticulturist, MCES

R. A. Haygood, Plant Pathologist, MCES

T. S. Brook, Entomologist, MCES

J. L. Peeples, District Agent, MCES
Northeast District

Preface

Establishing a vineyard requires a large capital investment over a three-year period (as much as \$4,000/acre at 1983 prices), and maintaining a vineyard is labor intensive and costly. Consequently, establishing a vineyard without careful preplanning is an exercise of poor judgment. Some of the more important considerations in preplanning may be in the form of questions as follow:

1. Do I have an acceptable vineyard site?
2. Do I plan to produce muscadines for wine or for other uses? (The answer will determine the choice of varieties.)
3. Where can I get plants of the varieties I wish to grow?

4. What machinery do I need?
5. Do I need an irrigation system; if so, what types of systems are available and which is best for me?
6. What kind of trellises do I need and what kinds of trellis materials are best?
7. Do I know enough about the growth habits of muscadines to permit proper training and pruning of the vines?
8. What disease and insect problems can I expect?
9. Am I equipped and staffed to handle the harvest?

These questions are addressed in the Appendix to this bulletin. The Appendix also contains a list of references that may be helpful to those interested in more detail than

an abbreviated appendix permits.

Given the decision to establish a vineyard, how do you proceed? The first steps are selecting a vineyard site and liming it to bring soil pH to 7.0, making a plat of the proposed vineyard, deciding what varieties to grow and determining machinery needs. All other steps follow a logical sequence, and instructions for accomplishing each step are presented in this bulletin.

The growth habits of muscadines dictate the tasks required for vineyard management. The time of performance and instructions for accomplishing each step are presented in this bulletin.

Content

	Page
Vineyard Establishment	1
Setting Vines	4
Training Vines	5
"Geneva Double Curtain"	5
Single curtain or two-wire vertical trellis	7
Tying	7
Summer Training Precautions	7
Vineyard Management	8
Machinery Needs	8
Pruning	8
Removal of last season's growth	8
Spur thinning	9
Removal of tendrils	9
Fertilization	9
Weed Control	10
Disease Control	11
Pruning	11
Spraying	11
Insect Control	11
Harvesting for Fresh Market	11
Harvesting for Processing	11
Catch-frame harvesting	12
Machine harvesting	12
Appendix	13
Vineyard Site	13
Trellising	13
Trellis materials	13
Varieties	14
Irrigation	18
Trickle irrigation	18
Flood (furrow) irrigation	19
Sprinkle (overhead) irrigation	19
Diseases	19
Insects	19
Characteristics That Affect Harvesting	19
Sources of Vines	20
References	20

Establishment & Maintenance of Muscadine Vineyards

Vineyard Establishment

Select the vineyard site, have the soil tested and apply lime to bring pH to 6.5. Apply and incorporate lime before performing any of the operations required for vineyard establishment. Applying lime is much more difficult after the vines are set and the vine-support system is installed.

Determine row direction and make a plat of the vineyard. Space rows 12 ft apart and trellis posts and plants 20 ft apart---with plants by the trellis posts (Figure 1) or 10 ft from them (Figure 2). This planting pattern gives about 180 vines/acre.

Setting vines midway between the trellis posts requires fewer posts, and harvesting with catch frames is easier and better than if vines are set by posts.

If trickle irrigation is to be used, select the system. *The system that requires the least tubing (Figure 3) must be installed before the trellis posts are installed and the vines are set.* The other system (Figure 4) may be installed after the trellis posts are installed and the vines are set.

Determine the type of trellis to be used and install it. (Note: The trellis

and the trickle irrigation system shown in Figure 4 may be installed after the vines are set; however, installing these support systems after vines are set increases the likelihood of vine damage. Also, young vines normally require water during or immediately after planting, and training of vines begins soon after the newly planted vines break dormancy. Performance of these two steps in vineyard establishment is much easier if the support systems are in place.)

Determine the variety or varieties to be planted. The use for which the

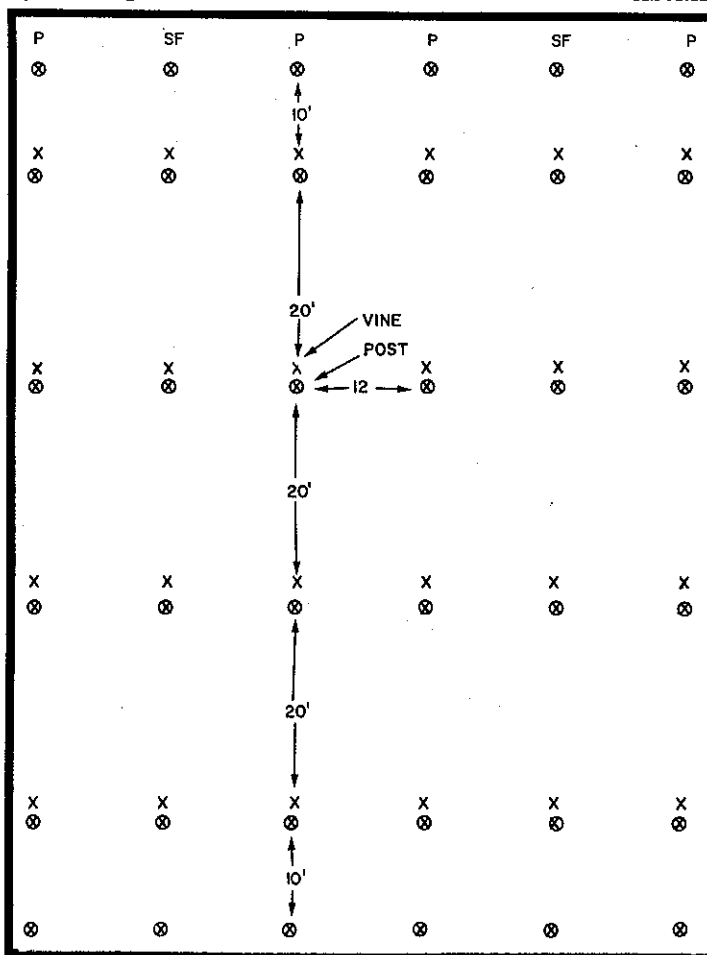

Figure 1. Plat of a vineyard with vines set by the trellis posts (P = varieties with pistillate flowers, SF = varieties with self-fertile flowers)

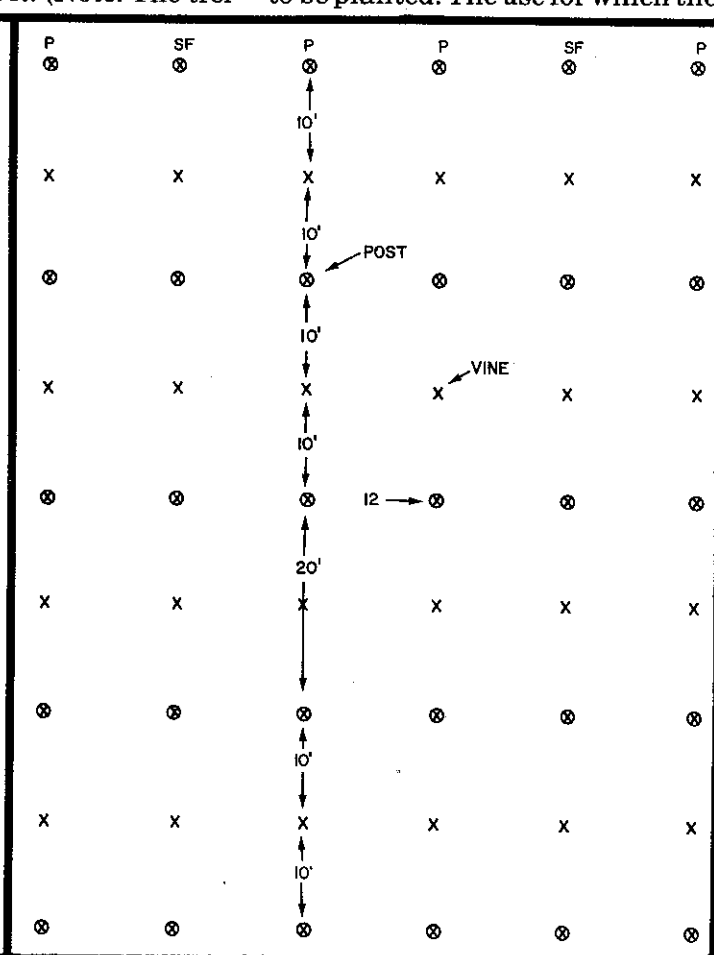

Figure 2. Plat of a vineyard with vines set 10' from the trellis posts (P = varieties with pistillate flowers, SF = varieties with self-fertile flowers)

berries are intended dictates the choice of varieties. The varieties that researchers have found to be best for the various uses are presented in the Appendix to this bulletin.

An overriding consideration in the selection of varieties is whether they have self-fertile flowers or pistillate flowers. Varieties with self-fertile flowers do not require pollinators, and those with pistillate flowers do. *The recommended planting pattern in a vineyard containing pistillate varieties is one row of self-*

fertile varieties between two rows of pistillate varieties. Designate the planting pattern, by varieties, on the vineyard plat (Figures 1 and 2).

Determine machinery needs. A tractor is required for site preparation and for setting trellis posts. A tractor of any size will suffice, but size of tractor selected should be based on the limits set on tractor size by vineyard management practices (See machinery needs, page 8).

Provide good trafficability,

erosion control and nitrification of the soil by maintaining a cover crop such as a combination of grass and clover. Confine cover crops to an 8 ft-wide strip between the rows (Figure 5). Never let grass, clover or weeds grow under the trellis. Manage the clover stand to permit reseeding each year. Mow warm-or cool-season grass cover crops frequently to prevent reseeding (heading out) and to maintain a neat appearance of the vineyard floor.

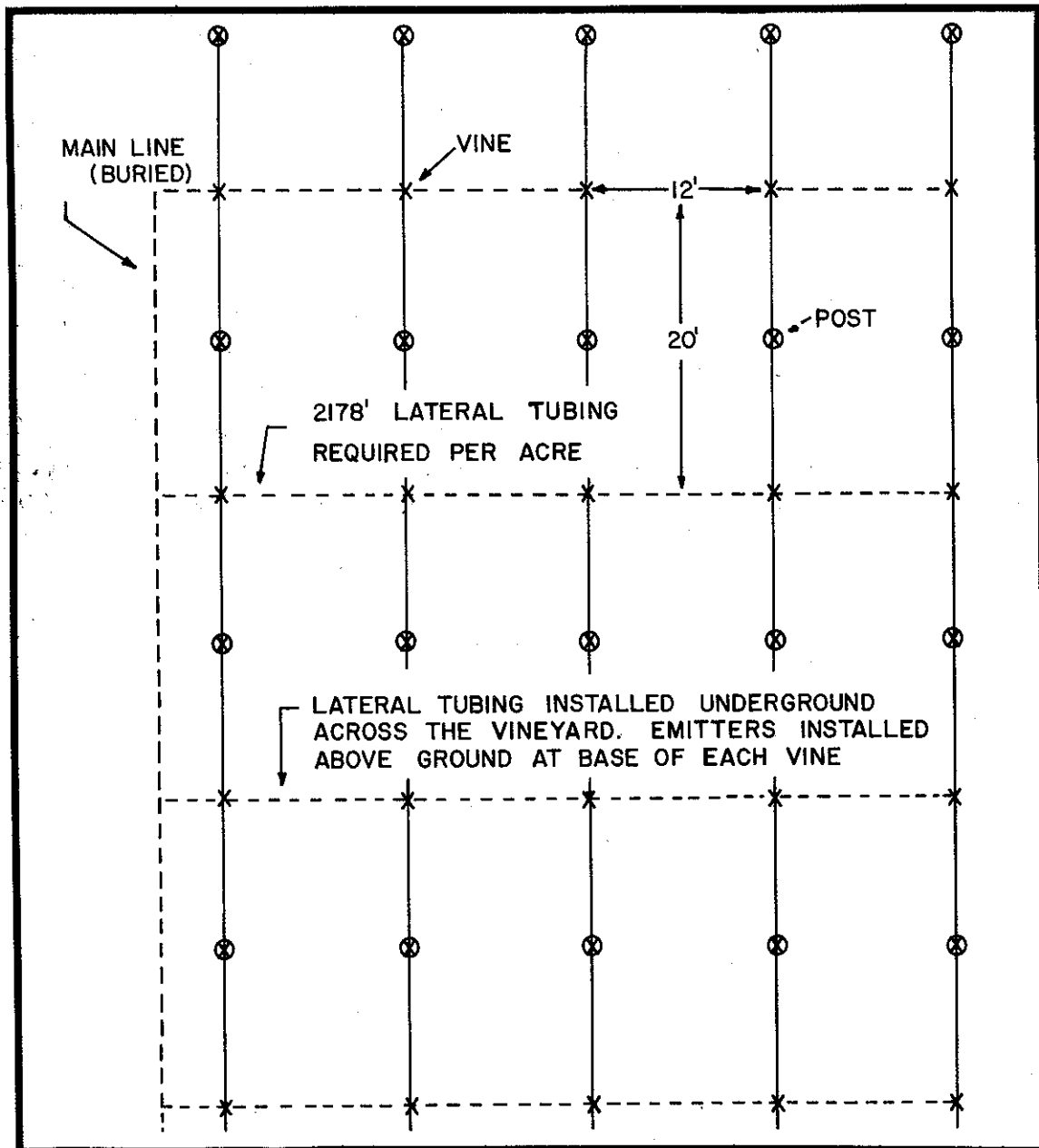

Figure 3. Design of the trickle irrigation system that requires only 2178' of lateral tubing per acre

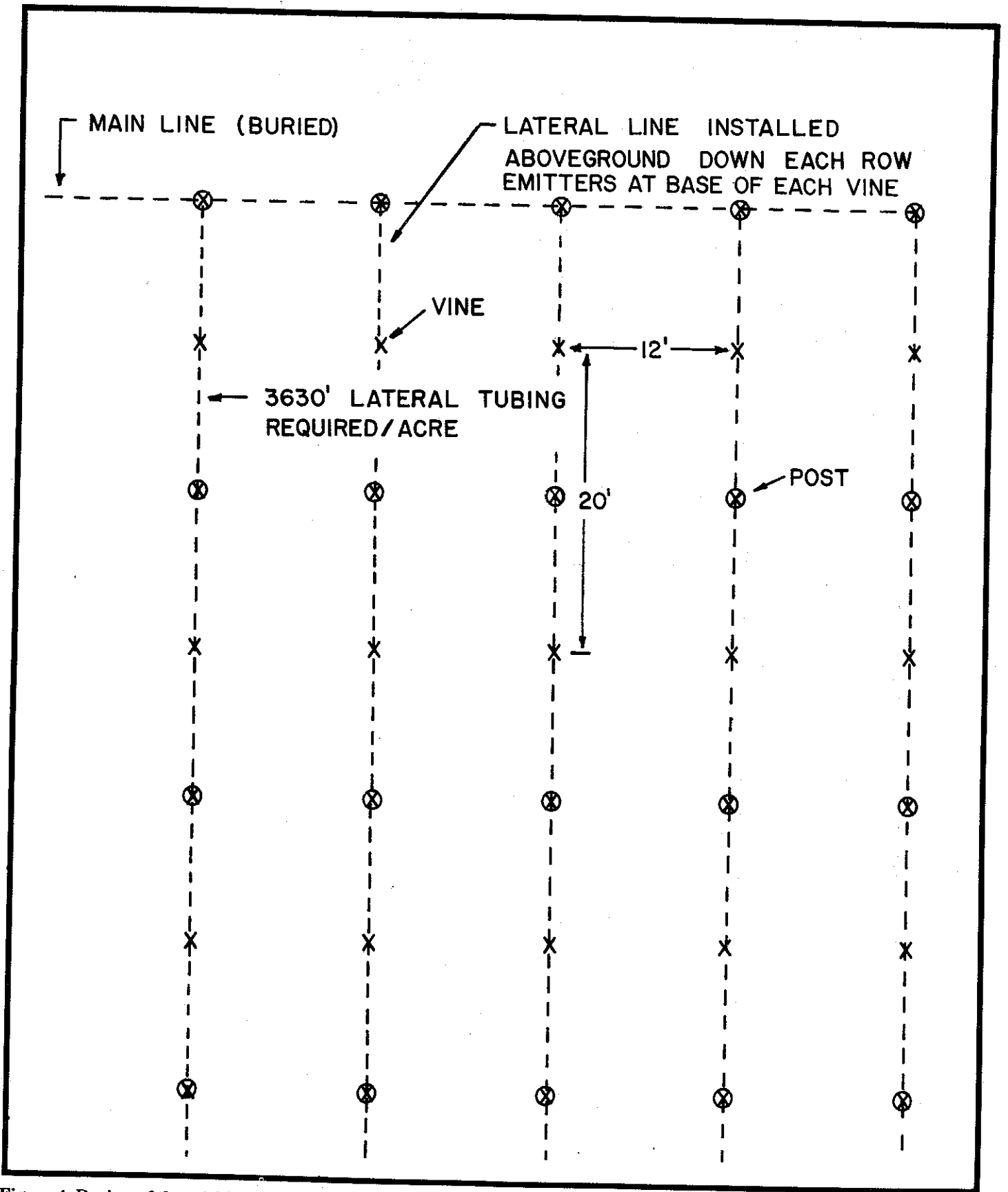

Figure 4. Design of the trickle irrigation system that requires 3630' of lateral tubing per acre.

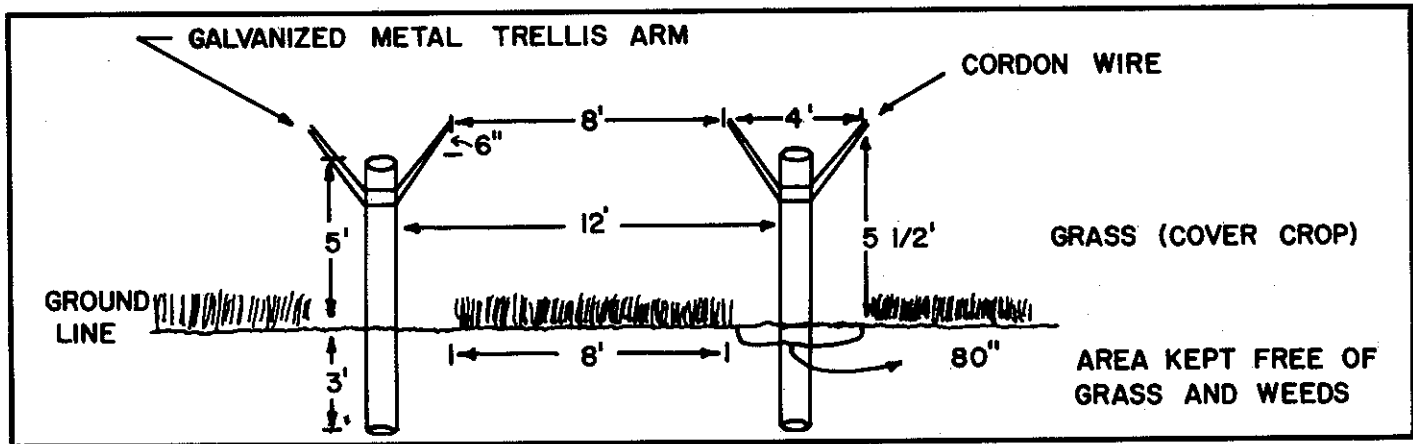

Figure 5. Horizontal and vertical dimensions of a vineyard designed for the preferred "Geneva Double Curtain" trellis.

Setting Vines¹

Set vines in late winter (February or March). Most nursery plants are dormant, bare root and packed for shipment in moist peat mess or other materials. If vines cannot be set promptly, store them in a cool place (35-40° F) or heel them in, using a good moist sandy loam soil or a good potting mix. (*Never let roots dry or freeze.*)

Pruning may be necessary before planting---If the root mass is more than 12-15 inches long, cut it back so that roots do not have to be packed or folded in the hole.

Spread the roots and never plant more than 12 inches deep.

Dig the hole large enough that the first new root growth will be in soil used to fill the hole.

Plant vines so that the soil line is 4 to 6 inches above the origin of the first root and prune the above-ground part of the stem to three to four buds (Figure 6).

If planting is delayed until vines have started to grow or if weather and soil conditions are conducive to growth, water the vines during or immediately after planting. *Never let new transplants stand in dry soil after spring weather is conducive to growth.* Irrigate during dry springs and summers to assure vine survival, especially in the first year after transplanting.

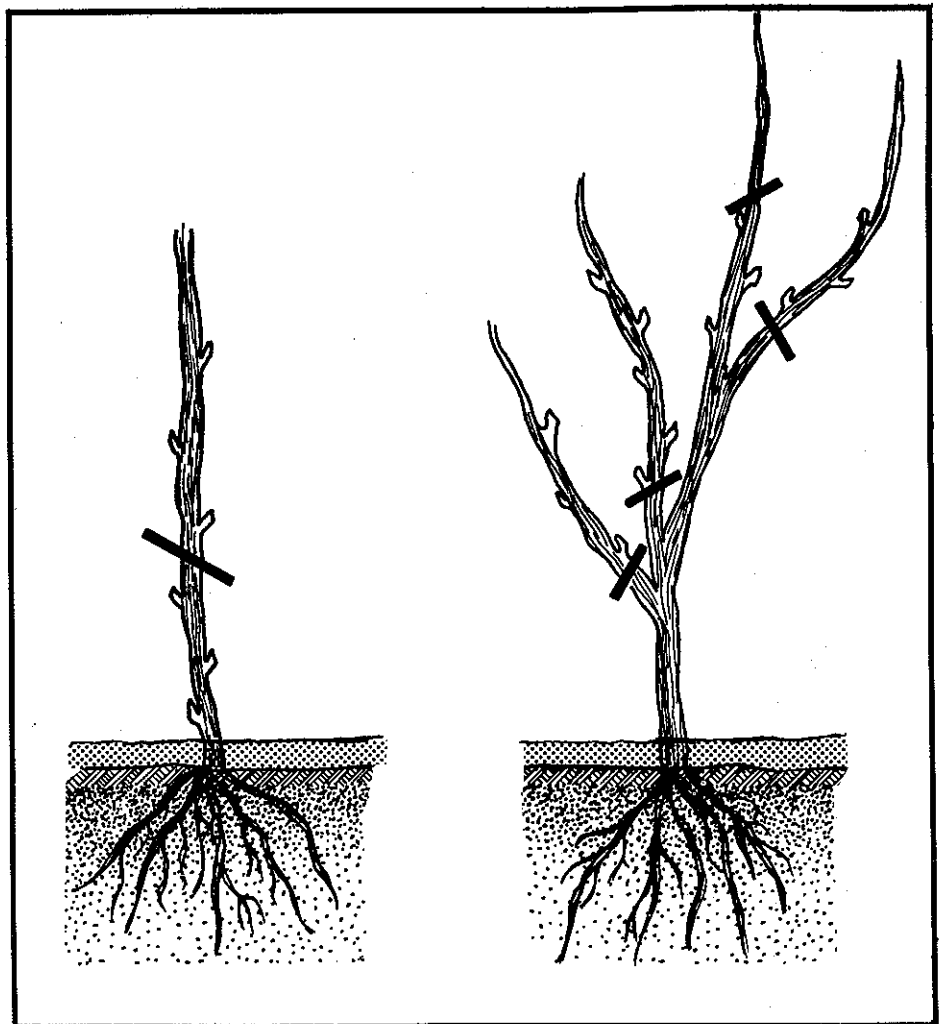

Figure 6. Single-stem, bare-rooted or potted vine pruned to leave three buds (left) and multi-stem, bare-rooted or potted vine pruned to leave three buds (right) on a single stem

¹Two-year old bare-root or one-year old vines in containers are preferred.

Training Vines

When a newly planted vine breaks dormancy, shoots may emerge from the three or four buds left after pruning. Choose one shoot to form the vine trunk and remove all others (Figure 7). As this shoot develops, provide some type of vertical support. This can be done by training the shoot up the trellis post if the vine is planted at or near the post. If the vine is planted between the trellis posts, support it with a stake or string. A vertical support makes vine training easier and facilitates the development of a straight trunk. Straight trunks are preferred because they are less likely to be damaged by passing equipment.

As the trunk-forming shoot grows, buds will develop in the leaf axils and produce third-order branches

or laterals. Remove these to promote faster growth of the trunk shoot (Figure 8).

"Geneva Double Curtain"

When the trunk-shoot tip reaches the bottom of the trellis arm or 18-24 inches below the trellis wires (Figure 9), pinch it to force branching. The point of pinching is particularly important for muscadines that are to be harvested mechanically, because the vine trunk may be split by the harvester if the vine is pinched too high. The first branching point must not be above the pivotal point of the trellis arm.

Pinching forces shoots to grow from the buds in the leaf axils just below the pinch. Select two shoots to grow up to the trellis wires (cordon wires). When this growth stage is reached (Figure 10), pinch the shoots

2 to 3 inches below the wires to force growth of lateral shoots. Select four shoots and train them along the trellis wires to a distance of 10 ft from the head of the vine. This development is hastened by preventing lateral shoot growth (Figure 11).

Check the developing vines once each month or, preferably, twice each month and perform needed pruning and tying-training operations (Figure 12). Pinch each shoot when it reaches 10 ft in length (usually in the second year) to form the four cordon arms, which account for all future growth. Restrict all further lateral growth to the four cordon arms and let them grow to the fullest extent.

Maintaining balance in vine development is essential--the two



Figure 7. A three-bud, single-stem vine after the first few weeks of growth, before pruning for trunk-shoot selection (left) and after pruning for trunk-shoot selection (right)

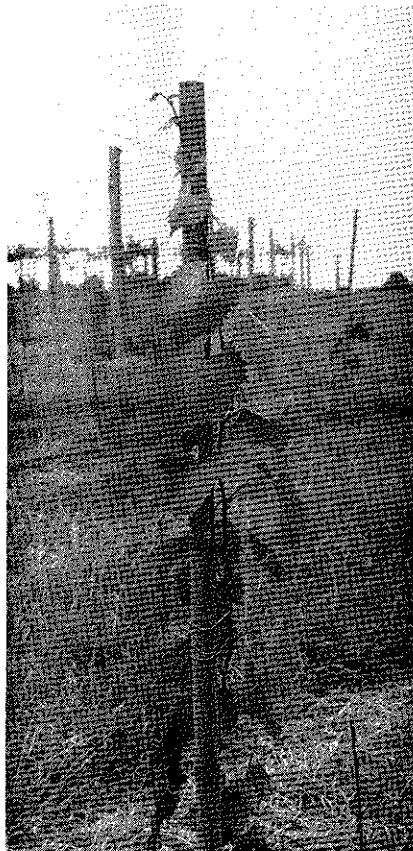
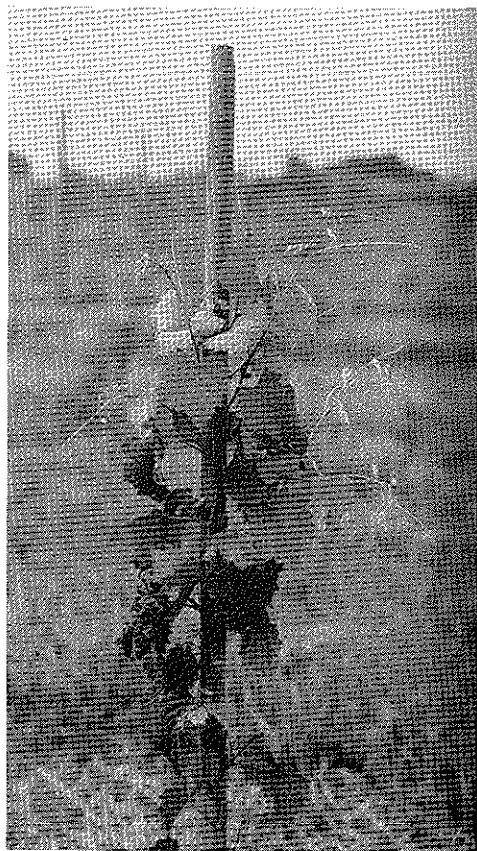

Figure 8. Third-order laterals or branches on the trunk shoot, before pruning (left) and after pruning (right)

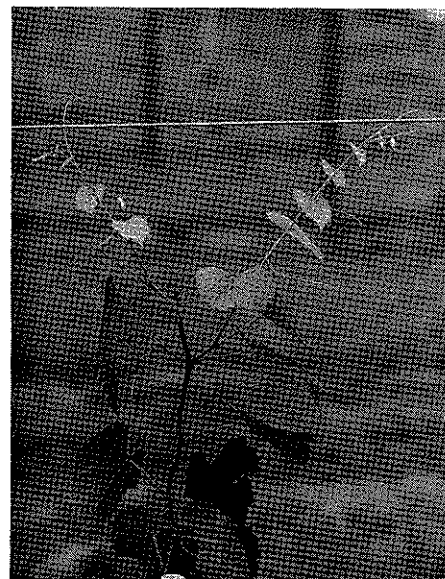

Figure 9. Trunk shoot pinched 18 to 24 inches below trellis wires

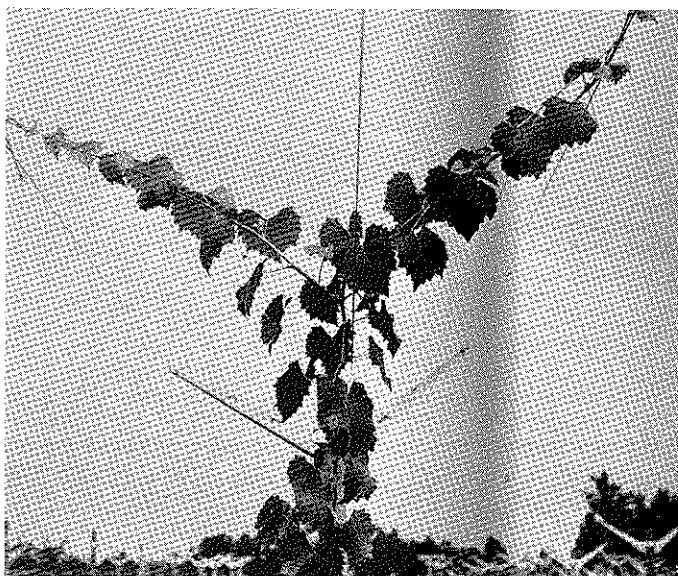

Figure 10. Shoots growing to the trellis wires before pinching (left) and cordon shoots starting down the trellis wires after pinching (right)

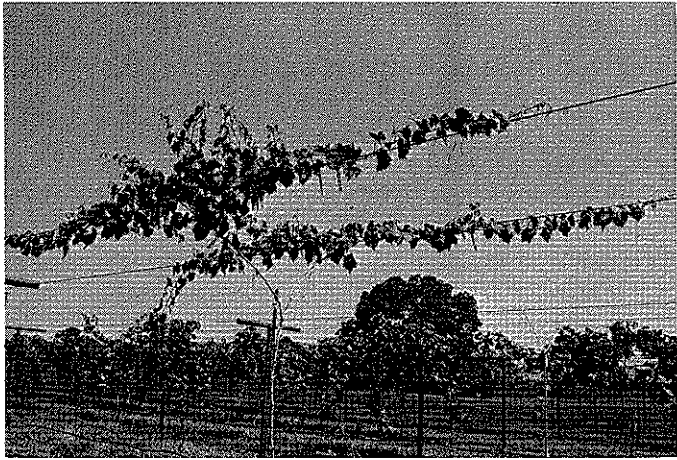

Figure 11. Lateral shoot growth on the cordon arm before pruning (left) and after pruning (right)

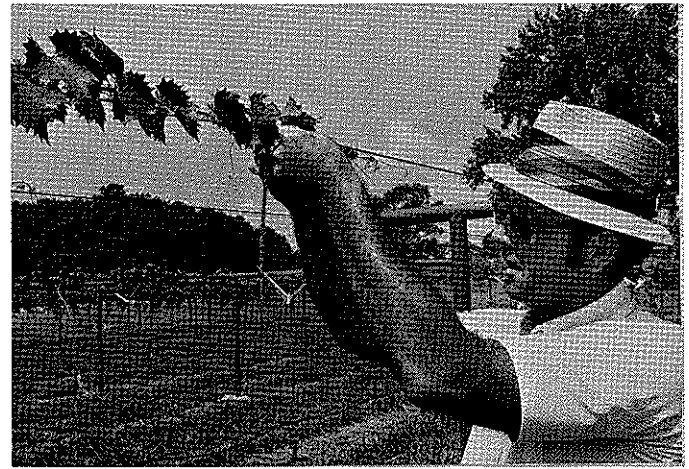

Figure 12. Cordon arm before tying (left) and being tied to the trellis wire (right)

shoots that form the head of the vine and the four cordon shoots should develop with equal vigor. If growth of any shoot exhibits dominance, pinch it and select another lateral shoot to continue the development process.

Single curtain or two-wire vertical trellis

Let the trunk shoot grow past the lower trellis wire to the upper trellis wire (or the top of the post) and pinch it. Select four lateral shoots---two at the bottom wire and two at

the top wire---and train them along the wires as described for the "Geneva Double Curtain".

Tying

When shoots are growing up a post, stake, string or along a trellis wire, tie them as they grow. Several available materials work well; e.g., plastic tape fastened with staples, plastic interlocking ties, natural and synthetic string and plastic interlocking chains (Ag-ties®). The interlocking plastic chain (Figure 13) is popular.

Regardless of type of material, a tie should not be tight enough to girdle the vine. Loosen or remove and replace ties that get too tight.

Summer Training Precautions

Do not cut unwanted shoots at their point of origin when pruning to hasten growth and development of the cordon shoots because this results in a spurless, non-fruitful cordon arm. Leave a spur with four or five leaves to promote development of fruiting wood.

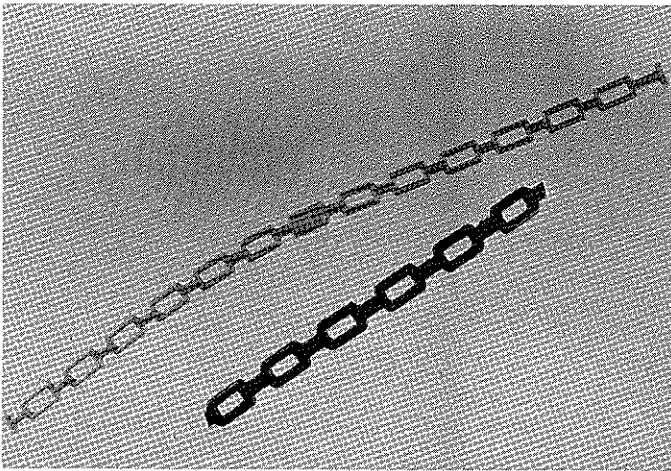

Figure 13. Typical interlocking plastic chains (left) and a plastic chain holding cordon arm to trellis wire (right)

Vineyard Management

Machinery Needs

A tractor, a trail mower and spray equipment are mandatory. Maximum usable space for a tractor between 12-ft wide rows in a vineyard trained to the "Geneva Double Curtain" is 8 ft (Figure 5). A conventional 25-horsepower (HP) tractor is satisfactory for all maintenance operations except mowing the 8-ft middle in one pass, which requires a 50-55 HP tractor that is too wide to pass safely between the rows.

One way to overcome this dilemma is to widen the row spacing, but this results in fewer vines and lower yields from a vineyard of a given size. A second approach is to use a conventional 25-HP tractor and make two passes over each middle with a smaller mower. An alternative is to acquire a narrow, low-profile tractor with enough horsepower to perform all establishment and maintenance operations, but they carry a heavy price tag.

Pruning

An unpruned muscadine vine (Figure 14) eventually becomes a mass of tangled, unproductive and diseased growth that is impossible to manage and is hard to harvest. A vine that is fully established and trained to a trellis system requires annual pruning, usually in January, February or March, to maintain the basic form. Other objectives of pruning include removal of dead, damaged or otherwise undesirable wood. Pruning also regulates vegetative growth and improves the quality and quantity of the crop.

Pruning consists of three distinctly different operations---(1) pruning last season's growth (one-year old wood) to fruiting spurs; (2) spur thinning (i.e., removing parts of some spurs and, in some instances, all of others to lessen crowding and (3) removal of tendrils to prevent girdling.

Removal of last season's growth

A short spur (Figure 15) is one with two or three buds, and a long spur is one with four to 10 buds. Varieties that exhibit low vigor (e.g., Fry and Magoon) generally should be pruned to short spurs. Unirrigat-



Figure 14. A typical tangled mass that results from lack of pruning or improper pruning

ed vineyards on poor sites also should be pruned to short spurs. Varieties that exhibit high vigor (e.g., Carlos and Regale) and irrigated vineyards on good sites may be pruned to long spurs.

Theoretically, vines with longer spurs (canes) yield more, but they must have the inherent capacity for supporting the increased shoot growth that results from leaving the spurs longer. They also must be growing in good soils with high fertility and must never be subjected to drought stress.

Significant yield increases have been obtained in the research plots at the Vegetable Unit of the MAFES South Mississippi Branch by pruning vigorous vines to canes with six to eight buds. Cane-pruned vines have been more difficult to manage, particularly pruning and harvesting, because of excessive shoot growth. However, yields following cane pruning have been 25% higher than yields following spur pruning.

Spur Thinning

Spur size is compounded with each annual pruning, and the cordons begin to get crowded after four or five years of production (Figure 16). Gradual thinning each year after the third bearing season will minimize yield reductions caused by the removal of spur wood.

Removal of Tendrils

Tendrils are hard to cut, and a sharp knife is the best instrument for the job. They also are hard to see (Figure 17), and care should be taken to assure that they are not overlooked.

The three pruning operations should be done sequentially; i.e., prune to the desired spur length first and then thin the spurs before removing the tendrils.

Fertilization

Follow the fertilizer recommendations included in the results of the soil test made to determine liming requirements of the vineyard site. During the first two years of vineyard development, apply part of

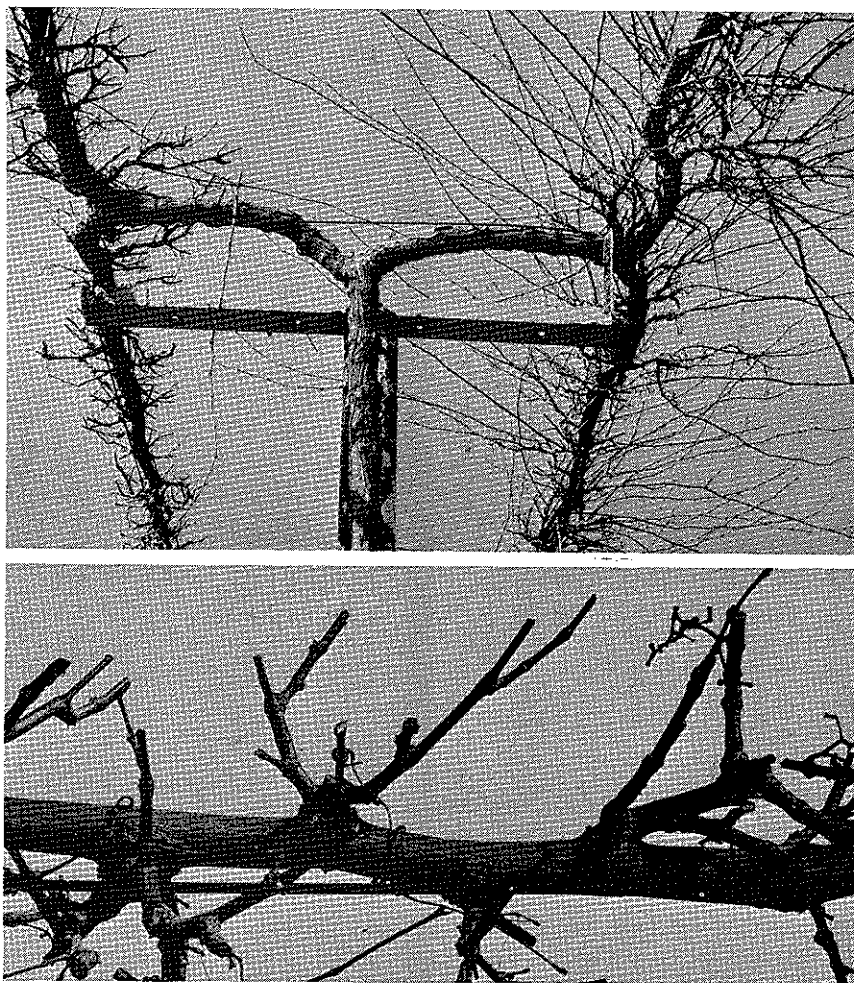

Figure 15. (Top) A cordon arm before pruning (right) and after pruning to short spurs (left). (Bottom) Close-up of short spurs

the fertilizer soon after growth starts in the spring, with additional small applications each fifth or sixth week thereafter. More frequent applications are necessary on sandy soils and in years when seasonal rainfall is above average. *Do not apply fertilizer after the first of July.*

Monitor the nutritional status of producing vineyards. Take soil and tissue samples and have them analyzed for determination of fertilizer requirements.

Take soil samples in the fall and be sure to request a test for magnesium. Tissue samples should be taken in June and should consist of at least 100 petioles (the part of the leaf that attaches the leaf blade to the shoot). Take only basal leaves on fruiting shoots, preferably those opposite fruit

clusters. Do not sample end vines, vines on outside rows or shaded vines. Sample each variety separately. The County Agricultural Agent or Cooperative Extension Service Specialist can provide assistance.

Mature vineyards on most soils should be fertilized only once, in late winter or before initiation of growth in early spring. Very sandy soils are an exception and should receive two applications---one before initiation of growth in the spring, the other about June 1.

The nutrient/water requirements of a producing vineyard diminish as the season progresses. Nutrient and water requirements are highest from bud break to flowering (about June 1) to support vigorous growth and development of the vine, shoots

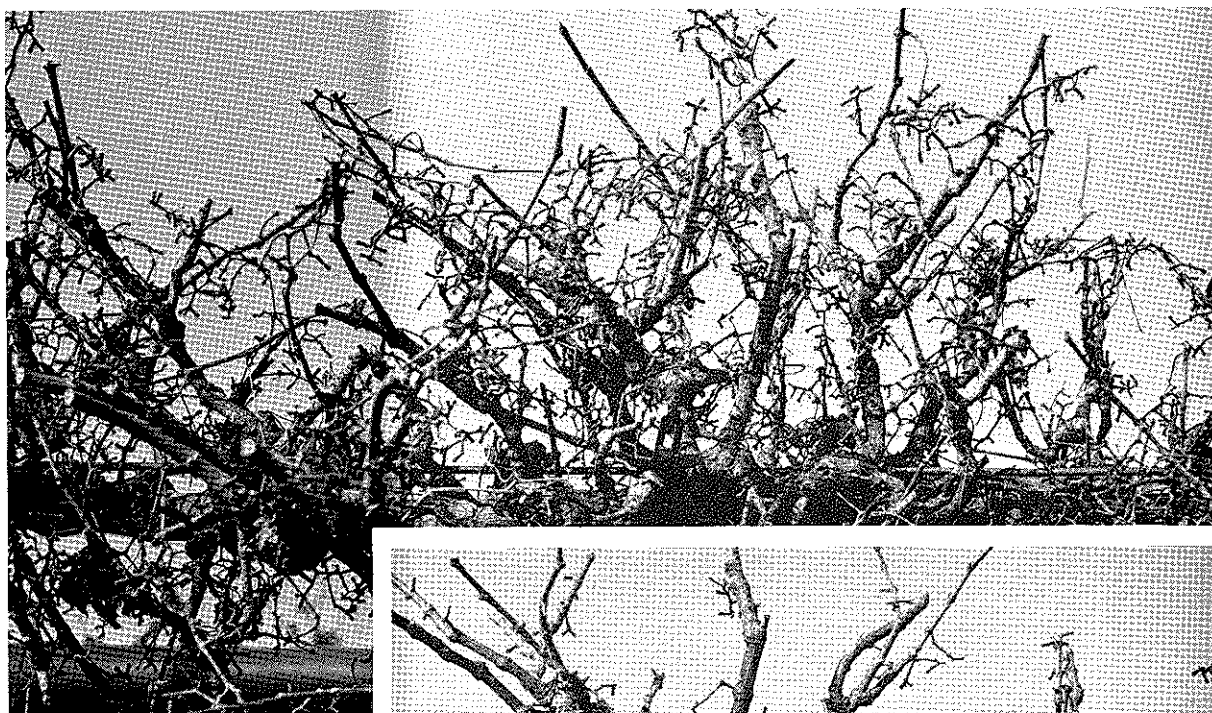

and flower parts. After flowering, nutrient and water availability should be limited to that required for maintaining the plant without stimulating continued vigorous growth of shoots. Vigorous vegetative growth throughout the summer diminishes the development of good sugar/acid ratios in the fruit and can lead to undesirable hardening of shoots.

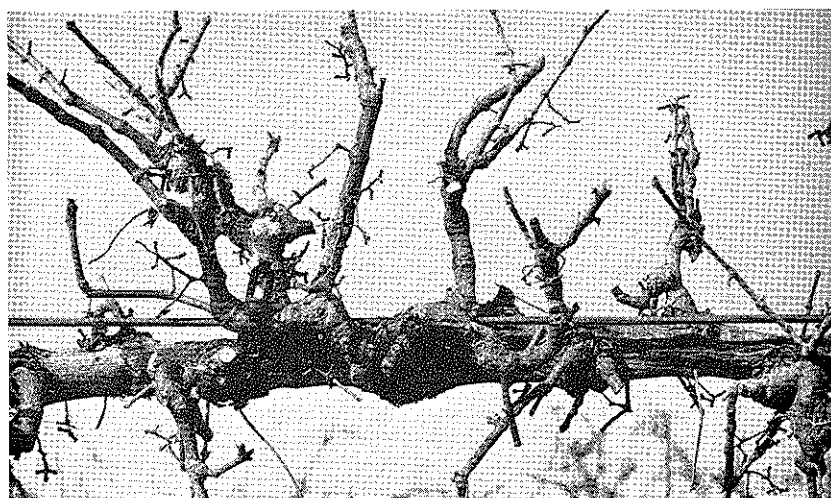

Figure 16. Crowded short spurs after four or five years of production (top) and after spur thinning (bottom)

Weed Control

A proposed vineyard site with populations of problem perennials (e.g., bermudagrass, johnsongrass and/or nut sedge) should be fallowed for one growing season and treated several times with an effective herbicide. Weed problems during the first growing season can be lessened by the application of herbicides before the vines are set. A combination of shallow cultivation and herbicides usually is necessary for control of weeds in the first two years after the vines are set. Weed control after the first two years usually can be accomplished with herbicides. The County Agricultural Agent or Cooperative Extension



Figure 17. Typical tendrils that need to be removed

Service Specialist can assist in the development of a herbicide program.

Muscadine production is not hindered by a permanent sod growing between the rows if the sod is mowed frequently and the area beneath the trellis is maintained free of grasses and weeds. The clean area under the trellis should be 40 to 48 inches wide (Figure 5).

Disease Control

Diseases on muscadines seldom were a problem in the past; however, with the introduction of new varieties and intensified plantings, some diseases have become so serious that a disease-control program is essential to the production of high yields of quality berries.

Pruning

Disease spots on canes serve as overwintering sites for fungi. Be sure to remove all canes that have disease spots.

Spraying

Proper application of chemicals for disease control is necessary for successful production. *Thorough coverage of leaves, berries and stems is important.* The amount of water needed for adequate coverage of vines varies. Some dilute sprayers may use more than 100-200 gal/acre, but low-volume equipment may apply only 20 gal/acre. Air-blast sprayers may be used for low-volume application; however, a tractor-mounted, high-pressure sprayer² (300-400 psi) also may be used.

Apply the first fungicide spray just before bloom, the second just after bloom. Continue spraying at two-week intervals, until early August for early-ripening varieties and mid-August for late-ripening varieties.

Use mancozeb (Manzate 200® or Dithane M 45®) at 3 lbs/acre until July 1 and use a tank-mix of Captan® 50 WP (3 lbs/acre) and Benlate® (1 lb/acre) thereafter. *Do not use mancozeb within 66 days or Benlate within seven days of harvest.* There is no waiting period for Captan.

Insect Control

Scout the vineyard carefully for signs of damage. Identify the pest and add an appropriate insecticide to the fungicide spray.

Look for the grape berry moth and leaf-feeding insects at the pre-bloom stage. Nuisance pests that can cause problems during pruning and harvesting are fire ants, bees and wasps. Eliminate fire ants by chemical treatment of the mounds. If a problem with bees and/or wasps is anticipated at harvest, add Sevin® or malathion to the pre-harvest fungicide spray.

Harvesting For Fresh Market

The key determinants of harvesting for fresh market are flavor and attractiveness. Fruit of high quality can be obtained with hand harvesting, and the prolonged ripening of berries permits harvesting of top-quality berries over a longer period.

If a large acreage or time constraints make once-over harvesting necessary, some fruit will not be at the optimum stage of maturity.

Grapes for the fresh market should be refrigerated at 35-40° F immediately after harvesting. Proper refrigeration can maintain berry quality for up to 14 days.

Harvesting For Processing

Monitor the maturity status of the berries. Maturity stage is determined by taking a sample of berries from the vineyard and analyzing the juice for pH, total acidity and Brix. Sample each variety separately.

Collect one cluster from each 10th vine of each variety. The cluster collected from each vine should be from different positions as sampling proceeds. Never sample end vines, vines on outside rows or vines near trees.

Crush the sample berries by hand or mechanically. Collect the free-run juice and filter it through several layers of cheesecloth. Analyze the juice for pH, total acidity and Brix, using the techniques outlined by R. P. Vine.³

Harvest when juice pH reaches 3.2. At this pH, total acidity values for most varieties range from 0.3 to 0.5. Check with the processor and harvest when delivery can be accepted. If the processor is more than one or two hours from the vineyard and the berries cannot be transported in a refrigerated vehicle,

²Details for construction of a sprayer of this type are available by writing and requesting two publications---Plan no. 2178 and Folder 299, Vertical Trellis Grape Sprayer. Address correspondence to Biological and Agricultural Engineering Extension, N. C. State University, Raleigh, NC 37607.

³Vine, R. P., Commercial Winemaking Processing and Controls

time the harvest so that the berries can be transported after sunset.

Catch-frame harvesting⁴

Catch-frame harvesting is practical in vineyards that are too small to justify the investment in a mechanical harvester, and frames have been designed for muscadines grown on the "Geneva Double Curtain" or the two-wire vertical trellis.

The catch frames fit under vines and collect the berries as they fall (Figure 18). Berries usually are shaken from the vine by striking the trellis wire with a padded club, and the catch frame funnels them into a suitable container (perforated plastic containers are used in MAFES vineyards). Catch-frame harvesting requires from three to five people for maximum efficiency. Average time required for one vine ranges from 3 to 7 minutes.

Machine Harvesting

Several mechanical harvesters (Figure 19) are adaptable for harvesting muscadines grown on the "Geneva Double Curtain" or the two-wire vertical trellis and accomplish the harvest without excessive berry damage. However, these harvesters are very expensive and are practical only for large vineyards.



Figure 18. Catch-frame being used to harvest berries from a vine growing on the "Geneva Double Curtain"

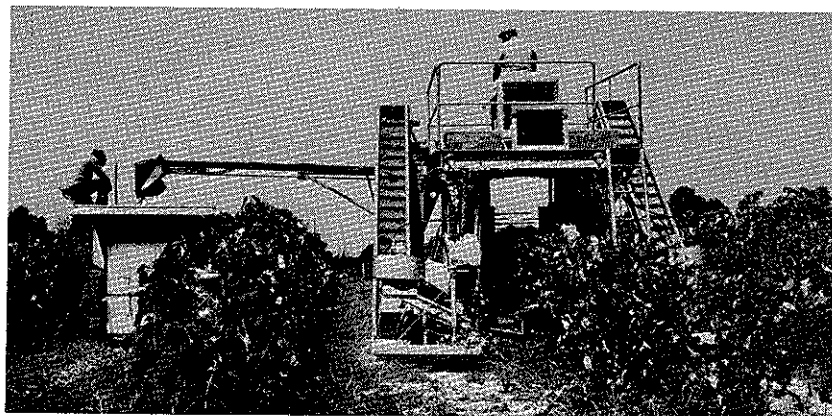

Figure 19. This mechanical harvester shown harvesting bunch grapes growing on a two-wire, vertical trellis can be used for harvesting muscadines grown on a two-wire vertical trellis and can be adapted for harvesting muscadines grown on the "Geneva Double Curtain".

⁴For details of the harvesting catch frames, see MAFES Information Sheet 1306, Catch Frames for Harvesting Muscadines.

Appendix

Vineyard Site

Soils of light to heavy texture are suitable, *but only if they have good internal drainage*. Loam to sandy loam soil with about 40% sand, 40% silt and 20% clay is preferable, medium fertility is desirable, and pH of 5.8 to 7.0 is desirable.

Preferred row orientation is north to south. However, topography of the vineyard site may not permit this, and the rows may have to be contoured. If the slope of the vineyard site mandates contouring, seek assistance from the Soil Conservation Service. The contour of the vineyard site is the primary determinant of the trellis type that is best suited. Contact a Cooperative Extension Service Specialist for assistance.

Trellising

Trellises for home plantings may be a fence or, if aesthetics dictate, may be many types of decorative arbors. Several types of trellises are suitable for commercial vineyards, but only two types are presented in

this guide---both of which are suitable for home or commercial plantings and permit machine harvesting. Costs of construction and yields differ significantly for the two.

The trellis best suited for commercial vineyards is the "Geneva Double Curtain", which is well suited for production of maximum yields and for mechanical harvest. Preferred construction is with No. 9 galvanized wire (or U. S. Steel high-tensile No. 12 wire) and galvanized metal arms (Figure 20).

Vines trained to a double-wire vertical trellis (Figure 21) can be harvested mechanically, but yields are lower than on a double-wire horizontal trellis---the upper cordon shades the lower cordon, and this retards growth of the lower cordon. The main advantages of vertical trellises are simplicity and lower initial cost.

End-post bracing is an important feature of any trellis---no trellis holds up well unless the end posts are anchored or braced properly, and good end-post bracing will save many hours of trellis maintenance.

Three end-post bracing designs that work well for trellis systems are illustrated in Figure 22. The design shown in Figure 22c should not be used for rows longer than 250 ft.

Trellis (or cordon) wires should be attached to the end posts to permit tension adjustment as needed. This can be done in several ways---turnbuckles, threaded eye bolts and wire vices (Figure 20) are three devices that work well.

Trellis materials

The most widely used material for posts is treated pine (4" top diameter). A good non-toxic wood preservative is copper chromium arsenate (CCA). Pentachlorophenol (penta) is another good preservative, but vines should not be permitted to contact freshly treated posts.

All wood materials used in trellis construction should be pressure treated according to the American Wood Preservative Association's (AWPA) standard C16. Wood materials so treated will last 20-25 years.

Trellis longevity is important because vines that are cared for

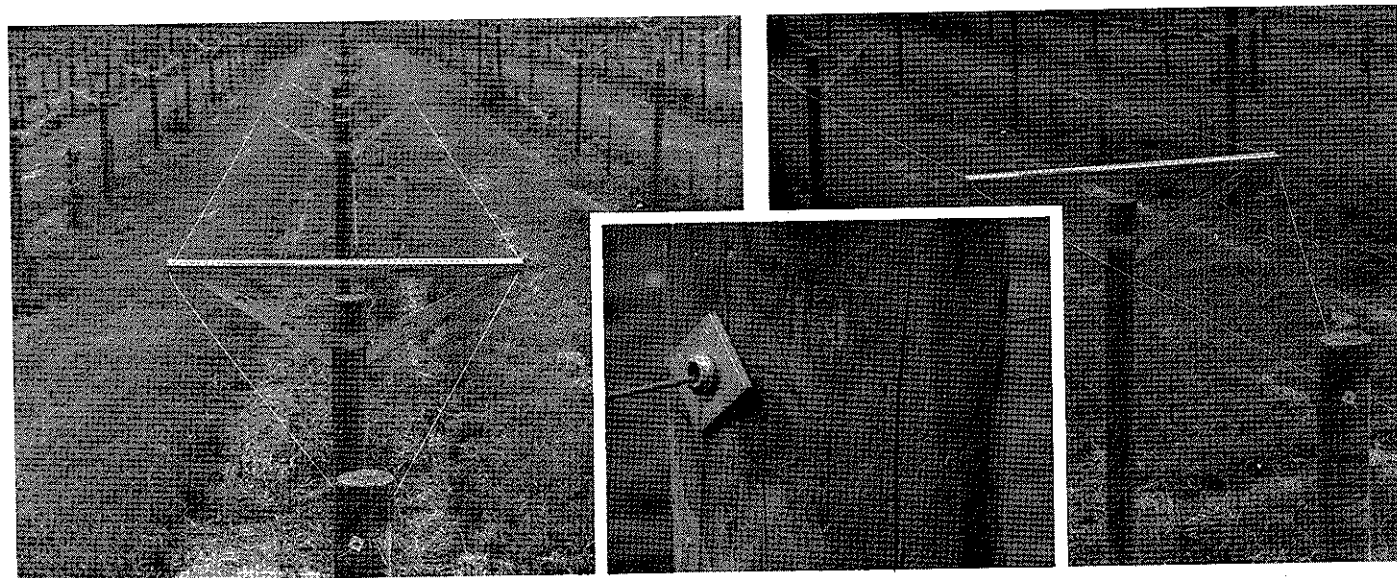

Figure 20. Two views of the preferred "Geneva Double Curtain" trellis constructed with U.S. Steel high-tensile No. 12 wire, Wolverine® galvanized metal arms, treated wood spacers, pressure-treated pine posts and wire vises, with close-up view of a wire vise (insert)

properly are capable of outlasting a trellis, and replacing a trellis in a mature vineyard is a formidable job. This is one reason why U. S. Steel high-tensile No. 12 wire is used in new MAFES vineyards.

Varieties

Muscadine varieties have been tested by the Mississippi Agricultural and Forestry Experiment Station (MAFES) since 1973 to determine their suitability for wine, non-fermented products and fresh markets (roadside and pick-your-own) in Mississippi. Tests have been located at four MAFES Branch Stations---South Mississippi Branch Fruit and Vegetable Unit at Beaumont, Truck Crops Branch at Crystal Springs, Delta Branch at Stoneville and Northeast Mississippi Branch at Verona. A younger vineyard at Mississippi State University is now producing.

Several muscadine breeder's selections from the North Carolina and Georgia Agricultural Experiment Stations have been tested in addition to named varieties. Two of the more promising North Carolina selections recently were released jointly by MAFES and the North Carolina Agricultural Research Service as Regale and Doreen.

Regale is self-fertile, black-fruited and heavy-producing. It exhibited good cold tolerance in areas approaching the northern limit for muscadines. It is resistant or tolerant to some diseases, and other diseases may be controlled by regular fungicide applications. The ripening season in Mississippi has been early to mid-September. Berries are larger than berries of Noble, a prominent black-fruited variety.

Regale has produced as large or larger crops than other black-fruited varieties. Regale produced 2.8 tons/acre/year more than any other variety at one branch station.

The most important use of Regale may be as a companion variety for Noble. Many good red wines are blends of two or more red varieties.

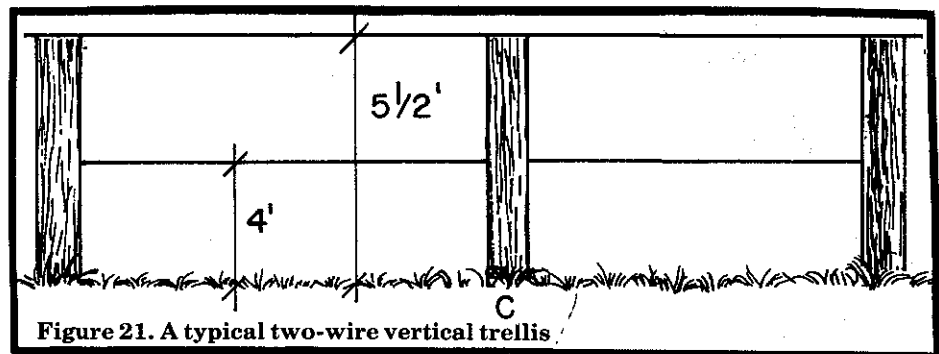

Figure 21. A typical two-wire vertical trellis.

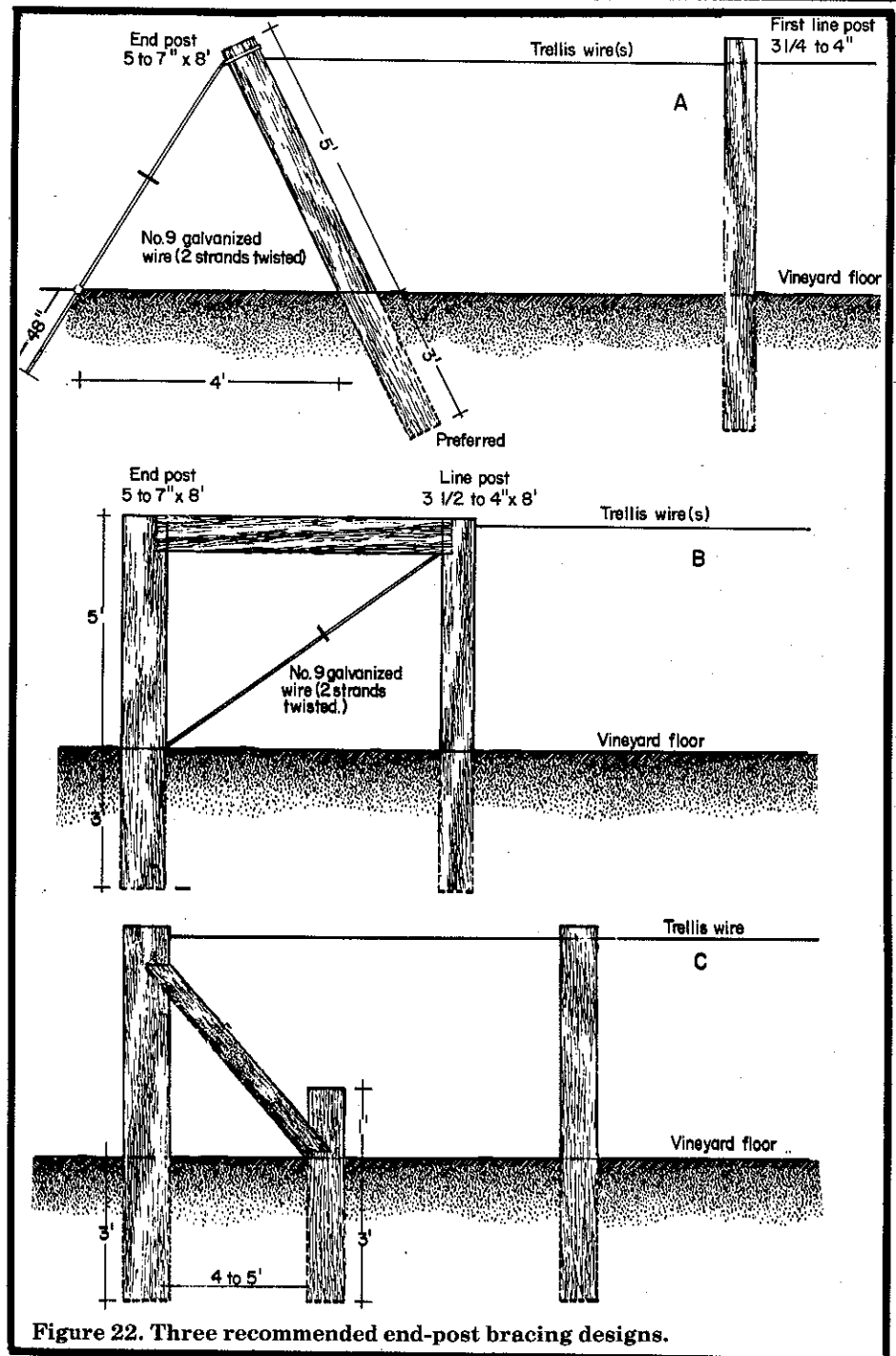

Figure 22. Three recommended end-post bracing designs.

Regale has been tested as a varietal red wine for seven years at North Carolina State University. Taste panelists have rated it average to good in overall wine quality but noted a less intense color than for Noble and Tarheel.

Doreen is self-fertile, bronze-fruited and highly productive. It ripens in late September, about three weeks after Regale, Noble, Carlos and Magnolia. It separates readily from the vine with a minimum of berries with torn skin. The flavor is pleasant, fruity and sweet and typical of muscadines.

Doreen yields generally have been excellent and have been better than yields of other varieties tested at Beaumont. Plot yields at Beaumont convert to 20.4 tons/acre in 1978 (fourth fruiting year), no crop in 1979 (Hurricane Frederick destroyed crop), 21.9 tons/acre in 1980, 22.4 tons/acre in 1981 and 18.6 tons/acre in 1982. In commercial muscadine-producing areas, 5 to 10 tons/acre are considered very good yields.

Doreen fruit can be made into a light golden wine equal in quality to that from the best bronze cultivars, and Doreen wines have been judged above average. Doreen can be used to extend the harvest and crush season for white muscadines in areas where it ripens uniformly.

Other muscadines that appear to be best for white wines are Carlos, Magnolia, Sterling, Nevermiss and Summit (a pistillate variety). Making good red wines from muscadines is difficult because of pigment instability, but very good wines have been made from Noble and Tarheel under carefully controlled conditions.

The quality for fresh market, "pick-your-own" and local sales of varieties evaluated since 1973 is acceptable except for Pride. The best varieties for storage or shipment to distant markets are Carlos and Southland. Large-fruited varieties (e.g., Jumbo, Fry and

Higgins) are very good choices for fresh market and "pick-your-own" vineyards. Watergate and Sugargate have potential for the fresh market, because their berries are very large, skins are thinner and flavors are different from Jumbo. However, Watergate and Sugargate have pistillate flowers and require pollinators, and Sugargate has been

notorious for poor yields in Mississippi.

Some characteristics of muscadine varieties that have been studied in Mississippi (Table 1), their yields (Tables 2, 3 and 4), sugar content of their juice (Tables 5 and 6) and size of their berries (Tables 7 and 8) are presented as a guide to selecting varieties for Mississippi vineyards.

Table 1. Flower type, fruit color, berry size and vine vigor of selected muscadine cultivars.

Cultivar	Flower type ¹	Fruit color	Berry size ²	Vine vigor
Albemarle	SF	Black	Medium	Medium
Bountiful	SF	Black	Small	Medium
Carlos	SF	Bronze	Medium	High
Chief	SF	Black	Small	Medium
Chowan	SF	Bronze	Medium	High
Cowart	SF	Black	Large	Medium
Creek	P	Black	Small	Medium
Dearing	SF	Bronze	Small	Low
Dulcet	P	Black	Small	Low
Fry	P	Bronze	Large	Low
Higgins	P	Bronze	Large	Medium
Hunt	P	Black	Medium	Very high
Jumbo	P	Black	Very large	Medium
Magnolia	SF	Bronze	Medium	Medium
Magoon	SF	Black	Small	Low
Nevermiss	SF	Bronze	Medium	High
Noble	SF	Black	Small	High
Pamlico	SF	Bronze	Medium	High
Pride	P	Black	Large	Very low
Redgate	SF	Bronze-red	Small	High
Regale	SF	Black	Medium	High
Roanoke	SF	Bronze	Medium	Medium
Scuppernong	P	Bronze	Medium	High
Southland	SF	Black	Medium	Medium
Sterling	SF	Bronze	Medium	Medium
Sugargate	P	Black	Very large	Medium
Summit	P	Bronze	Large	High
Tarheel	SF	Black	Small	High
Thomas	P	Black	Small	Medium
Watergate	P	Bronze	Very large	Medium
Yuga	P	Bronze	Small	High

¹SF = Self-fertile
P = Pistillate (female)

²Small = 2.1-4.0 gr/berry; Medium = 4.1-6.0 gr/berry;
Large = 6.1-8.0 gr/berry; Very large = 8.1-10.0 gr/berry.

Table 2. Three-year average yields of muscadines in replicated trials (averages of six vines of each cultivar at each location), by cultivar and location.

Cultivar	Vineyard location			Average
	Beaumont	Crystal Springs	Delta	
	-----lbs/vine-----			
Carlos	95.6	52.6	86.3	78.1
Cowart	82.2	42.0	82.1	68.8
Creek	91.1	46.1	65.7	67.6
Dearing	42.1	27.5	34.3	35.0
Higgins	97.5	56.7	85.0	79.7
Hunt	71.1	69.4	62.7	67.7
Magnolia	112.6	43.8	90.1	82.2
Noble	101.4	53.7	88.7	81.3
Regale	103.6	62.7	114.6	93.6
Roanoke	78.7	46.2	68.4	64.4
Scuppernong	66.1	45.7	44.7	52.2
Sterling	101.7	35.6	77.9	71.7

Table 3. Three-year average yields of muscadines in observation trials (averages of two vines at each location), by cultivar and location.

Cultivar	Vineyard location			Average
	Beaumont	Crystal Springs	Delta	
	-----lbs/vine-----			
Albemarle	44.5	23.5	43.8	37.3
Bountiful	45.8	38.0	63.3	49.0
Chief	46.0	57.0	48.5	50.5
Chowan	19.1	23.7	32.2	25.0
Dulcet	46.4	40.7	49.2	45.5
Fry	101.4	41.7	62.5	68.5
Jumbo	95.6	41.7	99.3	79.9
Magoon	42.9	29.5	40.5	37.6
Nevermiss	60.4	26.3	52.7	46.5
Pamlico	31.8	20.2	24.5	25.5
Pride	52.5	31.8	34.5	39.6
Southland	44.6	32.0	69.2	48.6
Summit	95.4	28.5	85.8	69.9
Tarheel	81.7	44.0	58.8	61.5
Thomas	67.3	42.0	73.3	60.9
Yuga	52.7	46.3	67.2	55.4

Table 4. Yields in the first four production years of the MAFES vineyard at Beaumont (averages of six vines of each cultivar), by cultivar and year.

Cultivar	Production year			
	1978	1977	1976	1975
	-----lbs/vine-----			
Carlos	85.7	124.3	109.7	52.6
Cowart	138.4	125.0	93.7	27.9
Creek	120.2	129.4	95.2	45.3
Dearing	77.4	65.5	45.1	15.5
Higgins	188.1	137.9	129.4	25.0
Hunt	111.0	104.0	92.3	17.1
Magnolia	160.3	168.8	129.5	39.4
Noble	143.5	151.3	117.7	34.8
Regale	175.2	148.7	129.3	32.6
Roanoke	112.2	103.0	89.1	43.6
Scuppernong	100.8	95.7	83.0	19.5
Sterling	155.8	149.1	117.1	38.6

Table 5. Soluble solids in juice of muscadines from MAFES vineyards (three-year averages of six vines of each cultivar) by location.

Cultivar	Vineyard location				Average
	Beaumont	Crystal Springs	Delta	Verona	
	-----%				
Carlos	15.9	15.1	17.9	15.4	16.1
Cowart	17.7	14.9	17.9	16.6	16.8
Creek	16.9	16.9	19.2	17.9	17.7
Dearing	19.0	17.7	22.9	14.8	18.6
Higgins	16.1	15.1	15.3	17.4	16.0
Hunt	15.2	15.9	18.3	13.6	15.8
Magnolia	15.7	14.8	14.5	16.3	15.3
Noble	18.5	16.4	18.1	16.9	17.5
Regale	15.6	15.2	13.8	14.6	14.8
Roanoke	15.5	15.7	16.2	14.8	15.6
Scuppernong	15.9	14.4	17.3	15.7	15.8
Sterling	16.8	15.8	16.2	15.7	16.1

Table 6. Soluble solids in juice of muscadines from MAFES vineyards (three-year averages of two vines of each cultivar) by location.

Cultivar	Vineyard location				Average
	Beaumont	Crystal Springs	Delta	Verona	
	-----%				
Albemarle	18.1	17.7	19.5	18.2	18.4
Bountiful	17.7	16.6	18.6	16.4	17.3
Chief	18.7	19.1	20.8	15.8	18.6
Chowan	17.3	17.5	17.9	18.1	17.7
Dulcet	17.2	17.7	17.6	17.8	17.6
Fry	17.9	17.8	19.4	19.4	18.6
Jumbo	15.6	15.0	16.1	14.1	15.2
Magoon	20.9	19.9	21.5	18.7	20.3
Nevermiss	15.0	14.4	15.1	16.3	15.2
Pamlico	16.5	14.9	18.1	17.0	16.6
Pride	15.2	16.2	15.3	15.3	15.5
Southland	18.3	18.1	19.3	18.3	18.7
Summit	18.7	20.2	17.9	16.0	18.2
Tarheel	17.9	18.3	19.9	18.5	18.7
Thomas	18.9	15.9	19.7	17.0	17.9
Yuga	18.1	18.1	19.5	17.3	18.3

Table 7. Berry weights of muscadines from MAFES vineyards (three-year averages of six vines of each cultivar), by location.

Cultivar	Vineyard Location				Average
	Beaumont	Crystal Springs	Delta	Verona	
	-----gms/berry-----				
Carlos	4.9	3.9	4.5	5.0	4.6
Cowart	6.8	5.1	5.2	5.8	5.7
Creek	3.0	2.9	2.8	2.8	2.9
Dearing	3.1	3.1	2.9	3.0	3.0
Liggins	7.4	6.1	5.9	6.9	6.6
Hunt	4.6	4.1	4.5	4.3	4.4
Magnolia	5.2	4.9	4.2	4.7	4.8
Noble	3.0	2.9	3.0	2.6	2.9
Regale	4.7	4.7	4.0	4.3	4.4
Roanoke	4.4	4.3	4.4	4.5	4.4
Scuppernong	4.6	3.9	4.3	3.7	4.1
Sterling	5.7	5.2	4.9	5.7	5.4

Table 8. Berry weights of muscadines from MAFES vineyards (three-year averages of two vines of each cultivar), by location.

Cultivar	Vineyard Location				Average
	Beaumont	Crystal Springs	Delta	Verona	
	-----gms/berry-----				
Albemarle	5.7	4.8	4.7	4.6	5.0
Bountiful	3.4	3.2	3.3	3.0	3.2
Chief	3.2	3.4	2.8	3.0	3.1
Chowan	5.3	4.0	4.8	3.9	4.5
Dulcet	2.9	2.9	2.7	2.8	2.8
Fry	8.8	7.7	6.3	8.0	7.7
Jumbo	10.5	9.1	8.3	9.3	9.3
Magoon	3.1	3.2	2.8	3.3	3.1
Nevermiss	4.8	4.3	4.3	4.0	4.4
Pamlico	5.4	5.5	5.0	5.3	5.3
Pride	7.3	7.3	4.5	6.6	6.4
Southland	4.3	4.5	4.2	3.2	4.1
Summit	7.3	7.8	6.8	6.9	7.2
Tarheel	2.7	2.5	2.5	2.3	2.5
Thomas	3.3	3.6	3.0	2.5	3.1
Yuga	3.3	3.6	3.4	3.9	3.6

Irrigation

Investment in the establishment of a vineyard without providing a dependable irrigation system is an exercise of poor judgment. Vine losses in the first spring and summer after planting can be reduced by irrigation, and vine growth in the first two to three years can be enhanced by irrigation.

Irrigation in the first two years speeds establishment of uniform and healthy vines, and a first crop from all vines in irrigated vineyards normally is expected in the third year. A vineyard that is not irrigated may require three or more years to

obtain a complete stand, and production from all vines is not obtained until the sixth or seventh year.

Irrigation is less important after a vineyard is well established (four years or older) but can increase yields and improve berry quality, especially in dry years. Bearing vineyards should be irrigated to stimulate optimum growth from early spring through mid-July, the period that coincides with flower development, bloom, fruit set and early fruit development.

Vineyards should not be irrigated after the berries begin to ripen because irrigation stimulates growth of vines until first frost and

makes them more vulnerable to winter damage and/or winter kill. Vine growth should be permitted to slow naturally so that vines can harden properly to withstand winter temperatures.

First-year irrigation can be done with a *water trailer*, but this is a time-consuming method.

Trickle irrigation is the most efficient method but requires a filtering system for muddy water from ponds or lakes. Excellent results have been attained with two in-line swimming pool sand filters. Water from most wells can be filtered inexpensively unless it has high iron content.

Flood (furrow) irrigation can be used, but the vineyard must be on land with a slope that permits water to flow freely from the high to the low end of the vineyard.

Sprinkle (overhead) irrigation can be used. However, the investment is large, and high operation pressure is required to distribute large volumes of water. Another disadvantage of sprinkler systems is the wetting of foliage, which can create and/or compound disease problems. Also, an application during the pollinating period may reduce fruit set.

Diseases

Black rot (*Guignardia bidwellii*) appears on berries as dry, black and scabby spots. It can occur at any time before maturity but is found most often by the time berries are half grown. Berries of Higgins, Hunt and Scuppernong are especially susceptible.

The disease begins as tiny, reddish-brown spots on the upper surface of leaves. These spots grow to ¼ inch or more in diameter and turn brown with black borders. Small, black, pimple-like fruiting bodies, which contain the fungus spores, develop near the outer edge of the brown area. Sunken, dark cankers occur on new stems.

The fungus overwinters on infected canes and on berries that fall to the ground. Infection occurs on new shoot growth in the spring and spreads to young berries.

Bitter rot (*Melanconium fuliginum*) occurs primarily on berries and pedicels but also can cause tiny, dark flecks on young leaves, stems, blossoms and flower buds. Berries are more susceptible as they approach maturity.

The first sign of disease on the berry is a brownish, water-soaked spot that can resemble insect injury. These spots enlarge and rot the berry as it ripens, causing it to turn black and shrivel.

The fungus can overwinter in stem lesions or can be blown into vineyards. Higgins and Fry are extremely susceptible.

Ripe Rot (*Glomerella cingulata*) is difficult to distinguish from bitter rot without microscopic examination. It may appear a little nearer to harvest than does black rot, and symptoms on berries may be a little darker. Sunken or flat rotten areas appear on the surface of berries. Most of the berry is affected, and only a shriveled black shell is left.

The disease spreads rapidly from berry to berry during wet weather and is much worse when berries are injured by insects or damaged during harvest. Pink or light-brown fungus spore masses may appear on the surface of rotten berries. Higgins and Fry are extremely susceptible.

Cercospora or angular leaf spot (*Mycosphaerella angulata*) affects foliage only. Infection occurs in midseason and later and appears as tiny, brown, angular spots on leaves. If severe, it will cause yellowing and premature dropping of leaves. Severe leaf drop results in small berries with low sugar content.

Macrophoma rot (*Botryosphaeria ribis*) is caused by a wind-borne fungus and occurs on berries near harvest. It appears first as a round, light-brown spot that turns black and is slightly sunken. The black spot becomes surrounded by a greasy, greenish halo. Several spots can run together and make the berry a watery mass of rotten tissue. Hunt and Scuppernong are highly resistant.

Powdery mildew (*Uncinula necator*) occurs on berries in most stages of growth. A grayish and powder-like moldy fungus growth appears on the surface of young berries and reduces their size and quality. Affected berries become russeted and many crack and fall from the vine. Powdery mildew can occur on leaves in late fall but usually does little if any damage.

Insects

Insects found in vineyards are classified into four groups according to the types of damage they do.

Chewing insects make holes in leaves, buds or fruit and include many general feeders (e.g., grasshoppers, cutworms, grape flea beetle, grape berry moth and the adult grape rootworm).

Sucking insects cause yellowish, sickly vines that lack vigor. Nymphs and adults of grape leafhoppers cause these symptoms.

Root insects that damage bunch grapes are the grape rootworm, the grape root borer and the grape phylloxera. The grape rootworm feeds on small roots, and this slows vine growth. The grape root borer feeds in the wood and inner bark near ground level and kills vines. The grape phylloxera causes galls on the roots, and this saps the vines. The only root insect that affects muscadines importantly is the grape root borer.

Mites, thrips, scale and some caterpillars also may injure muscadine vines.

Characteristics That Affect Harvesting

Muscadine clusters are small, usually containing six to 24 berries. Mature berries of most varieties do not adhere to the stems as do those of bunch grapes, and berry fall (shattering) of early ripening berries results in loss of some of the crop.

Berries ripen unevenly because of the long flowering period (early May until mid-June), and the main crop (primary fruit set) is set over a three- to four-week period. Consequently, each cluster may contain flower buds, flowers and small berries at the same time. Also, each shoot has from one to three or more clusters, and the order of blooming of clusters is the one nearest the base of the shoot first, the one next to it second and the one farthest from the base of the shoot last.

Another characteristic that affects harvesting importantly is berry tear (wet stem scars). Berries often tear at the point of attachment to the cluster, and berry maturity affects the amount of tear. Berries that are fully mature when harvest-

ed usually fall with a dry stem scar, and many of those harvested before they are fully ripe have wet stem scars.

The percentage of berries with dry stem scars is higher for some varieties (e.g., Carlos and South-

land) than for others. If a vineyard is being established for fresh market sales other than "pick-your-own" or roadside stands, planting varieties with the highest percentage of dry stem scars should be considered.

Sources of Vines

All vines in the MAFES vineyards were obtained from

South Forest Rose Nursery, Inc.
Rt. 6, Box 1296
Hattiesburg, MS 39401

Owen's Vineyard and Nursery
Georgia Highway 85
Gay, GA 30218

Southern Orchard, Inc.
Rt. 5, Box 73-B
Louisville, MS 39339

Ison's Nursery and Vineyard
Brooks, GA 30295

Many garden centers, cooperatives and other nurseries in Mississippi now carry vines. Also, one of the five commercial wineries in the state currently is propagating and selling vines, and plants recently have become available from Nance Wholesale Nurseries, Inc., Rt. 4, Box 305B, Meridian, MS 39305.

The County Agent or Cooperative Extension specialist can assist in locating a convenient and reliable source of vines.

References

Clark, J. R., Catch Frames for Harvesting Muscadines, Information Sheet 1306, Mississippi Agricultural and Forestry Experiment Station, MS ST MS 39762

Common Insects and Diseases of Bunch Grapes, Cooperative Extension Service, Mississippi State University, MS ST MS 39762

Control of Grape Diseases and Insects in the Eastern United States, Farmers Bulletin 1893,

Superintendent of Documents, U.S. Government Printing Office, Washington D.C. 20402
Diseases of Muscadine and Bunch Grapes in North Carolina and Their Control, Bulletin 451, Agricultural Experiment Station, North Carolina State University, Raleigh NC 27607
Muscadine Grape Culture, Bulletin 739, Revised April 1979, Cooperative Extension Service, University of Georgia College of Agriculture, Athens GA 30601

Muscadines for the Home Vineyard, Cooperative Extension Service, Mississippi State University, MS ST MS 39762

Muscadine Grapes for Profit, Cooperative Extension Service, University of Georgia College of Agriculture, Athens GA 30601

Muscadine Grape Production for North Carolina, Cooperative Extension Service, North Carolina State University, Raleigh NC 27607

Acknowledgment

The reprinting of this publication has been funded in part by the following cooperators in Mississippi's muscadine industry:

Almarla Vineyards & Winery
Frost Bridge Road
Matherville, Mississippi 39360
Phone: (601) 687-5548

Nance Wholesale Nurseries, Ltd.
Route 4, Box 305B
Meridian, Mississippi 39305
Phone: (601) 679-8231

South Forrest Rose Nursery, Inc.
Route 6, Box 1296
Hattiesburg, Mississippi 39401
Phone: (601) 583-8913

Mention of a trademark or proprietary product does not constitute a guarantee or warranty of the product by the Mississippi Agricultural and Forestry Experiment Station and does not imply its approval to the exclusion of other products that also may be suitable.

Mississippi State University does not discriminate on the basis of race, color, religion, national origin, sex, age, or against handicapped individuals or Vietnam-era veterans.

In conformity with Title IX of the Education Amendments of 1972 and Section 504 of the Rehabilitation Act of 1973, Joyce B. Giglioni, Assistant to the President, 610 Allen Hall, P. O. Drawer J, Mississippi State, Mississippi 39762, office telephone number 325-3221, has been designated as the responsible employee to coordinate efforts to carry out responsibilities and make investigation of complaints relating to discrimination.

28078/2.2M